

Installation, Wiring and Operating Instructions

REGULUS SRS2 TE Solar Controller



CE

EN
v. 1.3

Regulus

CONTENTS

A.1	EC Declaration of Conformity	4	5.2. - System protection	25
A.2	General information	4	5.3. - Collector protection	25
A.3	Explanation of symbols	4	5.4. - Recooling	25
A.4	Changes to the unit	5	5.5. - Frost protection	26
			5.6. - Seizing protection	26
			5.7. - Collector alarm	26
B.1	Specification	6		
B.2	Temperature resistance table for Pt1000 sensors	6	6. - Special functions	27
B.3	Description	7	6.1. - Program selections	27
B.4	Scope of supply	7	6.2. - Pump settings V1	27
B.5	Disposal	7	6.2.1. - Type of pump	27
B.6	Hydraulic variants	8	6.2.2. - Pump	27
			6.2.3. - Output Signal	28
C.1	Wall installation	9	6.2.4. - PWM Off / 0-10V Off	28
C.2	Electrical wiring	10	6.2.5. - PWM On / 0-10V On	28
C.3	Installing the temperature sensors	11	6.2.6. - PWM Max/ 0-10V Max	28
			6.2.7. - Show signal	28
D.1	Terminal block wiring	12	6.3. - Speed control R1	29
D.2	Example of el. heating element wiring	13	6.3.1. - Modes R1	29
			6.3.2. - Purging time	29
E.1	Display and input	14	6.3.3. - Sweep time	29
E.2	Commissioning help	15	6.3.4. - Max. speed	30
E.3	Free commissioning	15	6.3.5. - Min. speed	30
E.4	Menu sequence and menu structure	16	6.3.6. - Setpoint	30
			6.3.7. - Temperature difference	30
1. - Measurements		17	6.7. - Heat quantity	30
			6.7.1. - Heat metering	30
2. - Statistics		18	6.7.5. - Antifreeze type	30
2.1. - Operating hours		18	6.7.6. - Glycol percentage	31
2.2. - Heat quantity		18	6.7.7. - Flow rate	31
2.3. - Graphic overview		18	6.7.9. - ΔT Offset	31
2.4. - Error log		18	6.8. - Sensor calibration	31
2.5. - Reset / Clear		18	6.9. - Commissioning	31
			6.10. - Factory settings	31
3. - Operating modes		19	6.11. - Start aid function	32
3.1. - Auto		19	6.12. - Time and date	32
3.2. - Manual		19	6.13. - Daylight saving time	32
3.3. - OFF		19	6.14. - Sleep mode	32
			6.15. - Temperature unit	32
4. - Settings		20	7. - Menu lock	33
4.1. - Tmin S(X)		20		
4.4. - ΔT Solar S(X)		20	8. - Service values	34
4.5. - Tmax S(X)		21		
4.14. - Auxiliary heat source		22	9. - Language	35
4.14.1. - TH Set		22		
4.14.2. - Hysteresis		22	Z.1 Malfunctions with error messages	36
4.14.3. - Aux. heat source sensor 1		22	Z.2 Replacing the fuse	37
4.14.4. - Aux. heat source sensor 2		22	Z.3 Maintenance	37
4.14.5. - T eco		22	Useful hints and tricks	38
4.14.6. - Energy saving mode		22		
4.14.7. - Periods		23		
4.15. - Recirculation		23		
4.15.1. - Min. set temperature		23		
4.15.2. - Hysteresis		23		
4.15.7. - Recirculation time programs		23		
5. - Protective functions		24		
5.1. - Anti Legionella		24		

This Instruction Manual applies to the following hardware version:

SRS2 TE

2 output mechanical relays 460 W

1 output mechanical relays 3.5 kW

3 inputs for Pt1000 temperature sensors

Safety Instructions

A.1 EC Declaration of Conformity

The manufacturer declares that the SRS2 TE Solar Controller is marked with the CE mark and conforms to the following relevant safety regulations:

- Directive 2014/35/EU - EU low voltage directive
- Directive 2014/30/EU - EU electromagnetic compatibility directive

A.2 General information

- please read carefully!

These installation and operating instructions contain basic instructions and important information regarding safety, installation, commissioning, maintenance and the optimal use of the unit. Therefore these instructions must be read completely and understood by the installation technician/specialist and by the system user before installing, commissioning and operating the unit. The installation shall be done in compliance with valid standards and rules. The controller does not under any circumstances replace any safety devices (e.g. safety valve, air vent valve etc.) to be installed into a solar circuit! Installation of the unit may only be carried out by a specialist who is trained on the required level.

For the user: Make sure that the specialist gives you detailed information on the function and operation of the controller. Always keep these instructions in the vicinity of the controller. Any changes to the controller or tampering with may pose a risk to safe operation of the appliance and to the complete solar thermal system..

A.3 Explanation of symbols



Failure to observe these instructions can result in danger to life from electric voltage.



Failure to observe these instructions can result in serious damage to health such as scalding, or even life-threatening injuries.



Failure to observe these instructions can result in destruction of the unit or the system, or damage to the environment.



Information especially important for the function and optimal use of the unit and the system.

Safety Instructions

A.4 Changes to the unit

- Changes, additions to or conversion of the unit are not permitted without a written permission from the Manufacturer.
- It is forbidden to install any additional components into the controller that has not been tested together with the controller.
- The controller shall not be used after an accident when its functions may have been affected – e.g. after a fire. The controller shall be switched off immediately.
- Use original spare parts only.
- Marking of the Manufacturer and Distributor shall not be altered or removed.
- All adjustments shall be done in compliance with this Guide.

Description

B.1 Specification

Electric specification::

Voltage	100 - 240 VAC +/- 10%
Mains frequency	50 - 60 Hz
Power consumption	0,5W - 2,5 W

Internal fuse T2 A / 250 V slow blow

IP rating	IP40
El. protection class	II
Overvoltage category	II
Pollution degree	II

	SRS2 TE
Mechanical relay, 460 VA (AC1), 460 W (AC3)	2 (R1, R2)
Mechanical relay, 3500 VA (AC2), 3500 W (AC3)	1(R3)
Pt1000 sensors, from -40 °C to +300 °C	3

Permissible cable length of sensors and accessories:

Collector sensor	<30 m
other Pt1000 sensors	<10 m
Mechanical relay	<10 m

Clock backup period 24 h

Permissible ambient conditions:

Ambient temperature:	
for controller operation	0°C...40 °C
for transport/storage	0°C...60 °C
Air humidity:	
for controller operation	max. 85% rel. humidity at 25 °C
for transport/storage	no moisture condensation permitted

Other specifications and dimensions:

Housing design	2-part, ABS plastic
Installation methods	wall installation, optionally panel installation
Overall dimensions	163 mm x 110 mm x 52 mm
Installation aperture dimensions	157 mm x 106 mm x 31 mm
Display	fully graphic display, 128 x 64
LED	multicolour
Operation	4 entry keys

Temperature sensors:

B.2 Temperature resistance table for Pt1000 sensors:

°C	0	10	20	30	40	50	60	70	80	90	100
Ω	1000	1039	1077	1116	1155	1194	1232	1270	1308	1347	1385

Description

B.3 Description

SRS2 TE Controller is designed for automatic control of solar thermal systems. The SRS2 TE model is intended to control solar thermal systems with one solar array and one solar consumer. The solar consumer can be a hot water storage tank, a heat exchanger for a swimming pool, and a thermal store for heating. All hydraulic variants are described in Chapter 2.

- both graphics and texts on a backlit display
- simple viewing of the current measurement values
- analysis and monitoring of the system also by means of statistical graphics
- extensive setting menus with explanations
- menu lock can be activated to prevent unintentional setting changes
- usual preset parameters in factory setting

B.4 Scope of supply

- SRS2 TE Controller
- 3 screws 3.5 × 35 mm and 3 dowels 6 mm diam. for wall installation
- 12 strain relief clips with 24 screws
- replacement fuse T2A/250V
- 3 Pt1000 temperature sensors

B.5 Disposal

IMPORTANT INFORMATION ON DISPOSAL IN COMPLIANCE WITH THE EUROPEAN DIRECTIVE 2002/96/ES

European Directive 2002/96/EC requires that the equipment bearing this symbol on the product and/or its packaging must not be disposed of with unsorted municipal waste. The symbol indicates that this product should be disposed of separately from regular household waste streams. It is your responsibility to dispose of this and other electric and electronic equipment via designated collection facilities appointed by the government or local authorities. Correct disposal and recycling will help prevent potential negative consequences to the environment and human health. For more detailed information about the disposal of your old equipment, please contact your local authorities, waste disposal service, or the shop where you purchased the product.



WEEE registration number: 02771/07-ECZ

Description

B.6 Hydraulic variants

1. Solar with hot water storage tank
2. Solar with hot water storage tank and el. heating element
3. Solar with hot water storage tank and gas boiler
4. Solar with hot water storage tank and heat pump
5. Solar with hot water storage tank w. recirculation
6. Solar with hot water storage tank w. recirculation and el. heating el.
7. Solar with hot water storage tank w. recirculation and gas boiler
8. Solar with hot water storage tank w. recirculation and heat pump

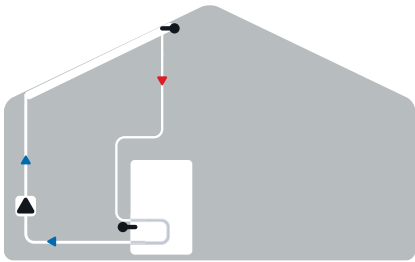

1. Solar with hot water storage tank

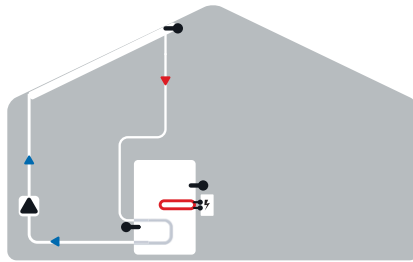

2. Solar with hot water storage tank and el. heating element

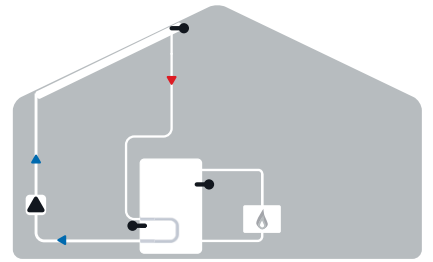

3. Solar with hot water storage tank and gas boiler

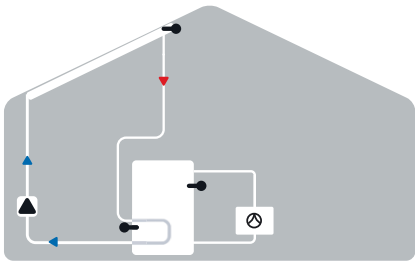

4. Solar with hot water storage tank and heat pump

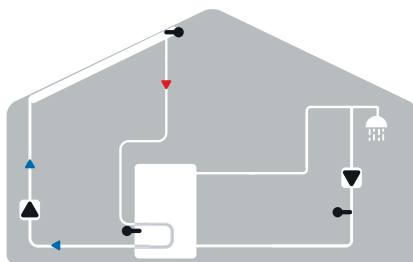

5. Solar with hot water storage tank w. recirculation

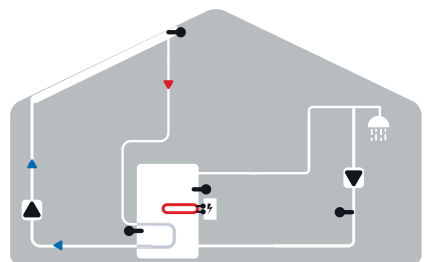

6. Solar with hot water storage tank w. recirculation and el. heating el.

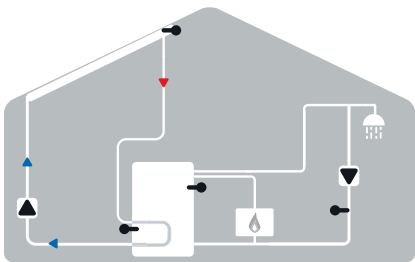

7. Solar with hot water storage tank w. recirculation and gas boiler

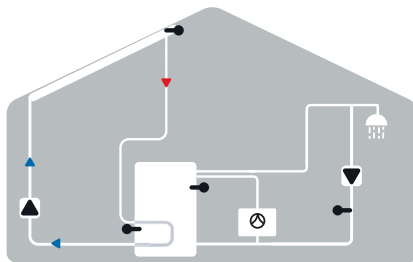

8. Solar with hot water storage tank w. recirculation and heat pump

For hydraulic variants 6, 7 or 8, an extra Pt1000 temperature sensor is needed.

Installation

C.1 Wall installation



Install the controller in dry areas only.

C.1.1

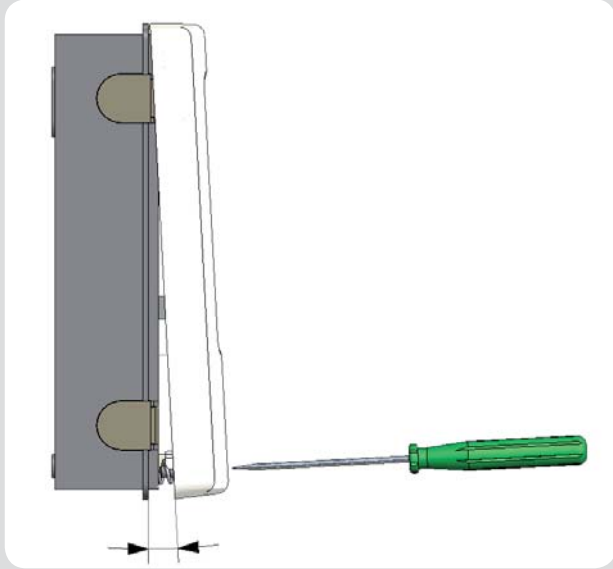

C.1.2

3x 3,5 x 30
3x Ø6

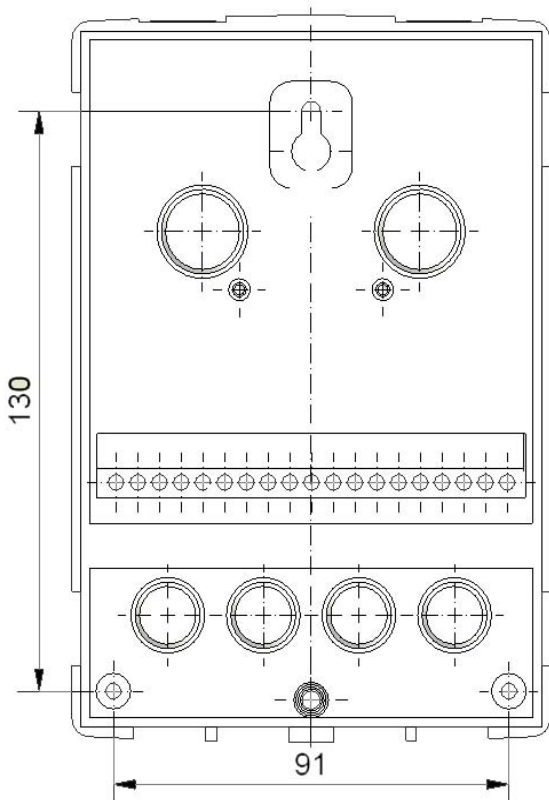

Installation instructions::

1. Unscrew cover screw completely.
2. Carefully pull the upper part of the housing from the lower part.
3. Set the upper part of the housing aside, being sure not to touch the electronics when doing so.
4. Hold the lower part of the housing up to the selected position and mark the 3 mounting holes. Make sure that the wall surface is as even as possible so that the housing does not become distorted when it is screwed on.
5. Mark the position on the wall with a pencil. Using a drill and size 6 bit, drill 3 holes at the points marked on the wall and push in the plugs.
Fig. C.1.2.
6. Insert the upper screw and screw it in slightly.
7. Fit the upper part of the housing and insert the other two screws.
8. Align the housing and tighten the three screws.

Installation

C.2 Electrical wiring



Danger

Before working on the unit, switch off the power supply and secure it against being switched on again! Check for the absence of power! Electric wiring may only be done by a specialist in compliance with valid rules. Do not use the controller if its case shows visible damage.



Warning

Low-voltage cables such as temperature sensor cables must be routed separately from mains voltage cables. Feed temperature sensor cables only into the left-hand side of the unit, and mains voltage and relay cables only into the right-hand side.



Warning

The controller is not equipped with a mains switch. For this purpose please use e.g. a circuit breaker.



Warning

The cables being connected to the unit must not be stripped by more than 55 mm, and the cable jacket must reach into the housing just to the other side of the strain relief.



Caution

Controller and VFS flowmeter have to have the same ground potential. The VFS flowmeter uses a functional earth connector (PELV). For this reason, the PE-connector of the controller has to be connected to the pipe system near the flowmeter.

Installation

C.2.1

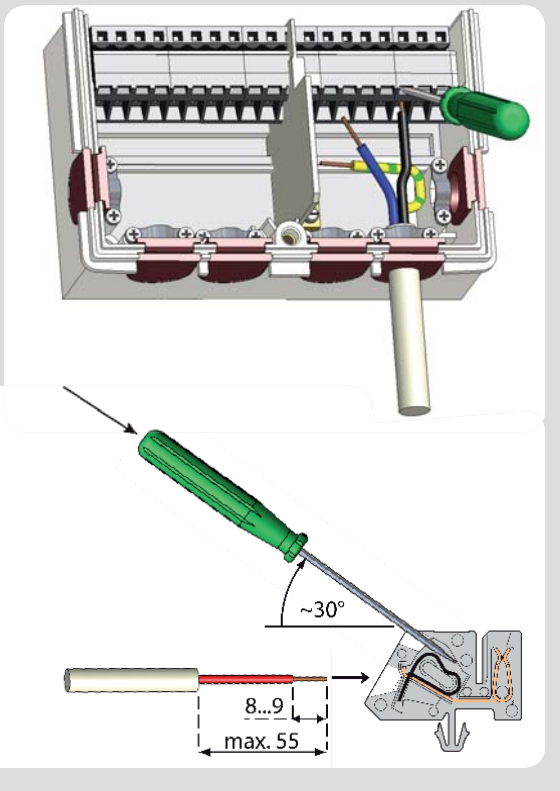

C 2. 1 Wiring instructions:

1. Select the necessary hydraulic variant (B.6).
2. Open the controller as described in C.1
3. Strip the cable by 55 mm max., insert and fit the cable strain relief. Strip the last 8-9 mm of all the wires (Fig. C.2.1)
4. Open the terminals using a flat screwdriver (Fig. C.2.1.) and wire the leads following the diagram.
5. Refit the upper housing part and fasten with screw.
6. Switch on mains voltage and place controller in operation.

C.3 Installing the temperature sensors

The controller operates with Pt1000 temperature sensors.



Max. sensor lead length for S1 sensor is 30 m and its cross section at least 0.75 mm². Max. sensor lead length for S2 and S3 is 10 m and its cross section at least 0.75 mm². Make sure there is no contact resistance in the wiring! Select the proper location for the sensor where it feels the right temperature. Use only immersion sensors. Pipe-mounted sensors only in exceptional cases.

Make sure that the terminals of extension cables and sensors are properly tightened. Use only immersion or pipe-mounted sensors.



The temperature sensor cables must be routed separately from mains voltage cables.



The VFS flowmeter shall be connected via a terminal. It is highly recommended to connect the VFS flowmeter to the solar return – this will prevent damage by a too high temperature. Check the flow direction.

Installation

D.1 - Terminal block wiring

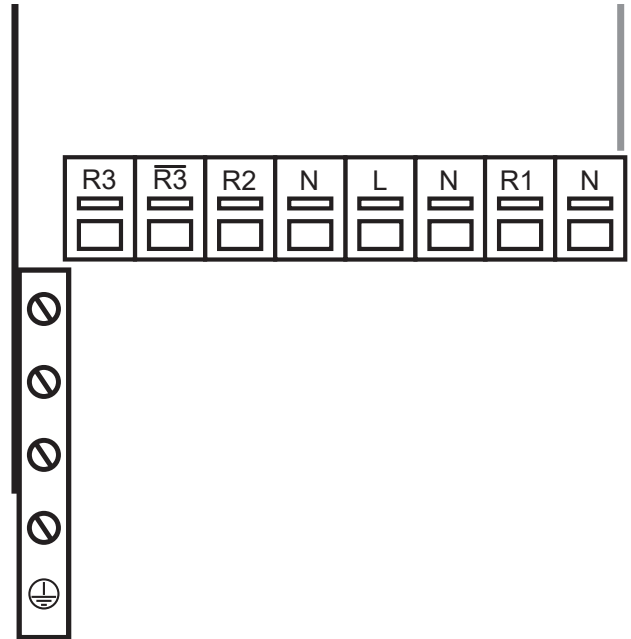
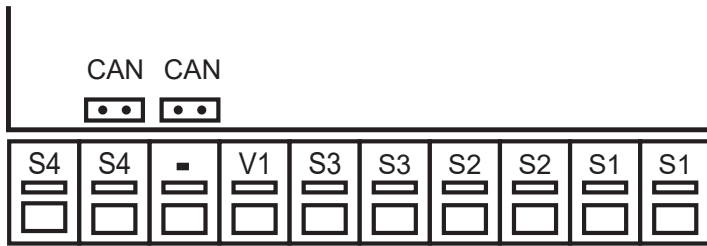

Extra low voltage

max. 12 V

Warning

Extra low voltage max. 12 V

Terminal: connection for:

S1 sensor 1

S2 sensor 2

S3 sensor 3

S4 sensor 4 *

V1 output 0-10V / PWM
for high-efficiency pumps



Mains voltage

230 V

Danger

Mains voltage 230 V 50 Hz

Terminal: connection for:

N neutral N

R1 relay 1

N Mains neutral N

L Mains phase L

N neutral N

R2 relay 2<

R3l relay 3l

R3 relay 3

PE protective conductor
(green-yellow)

*Sensor No. 4 is not included in supply!

Installation

D.2 Example of el. heating element wiring

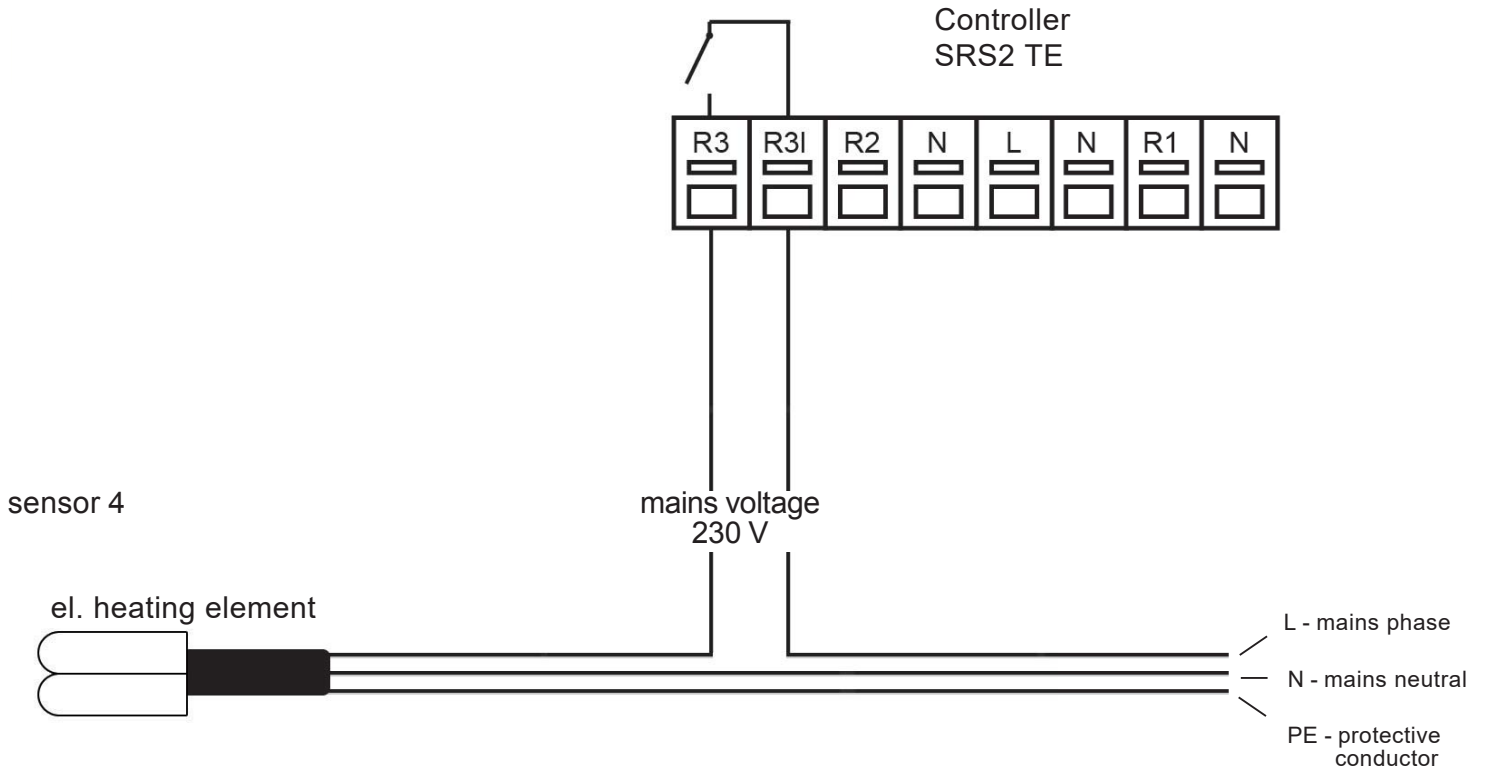

Operation

E.1 Display and input

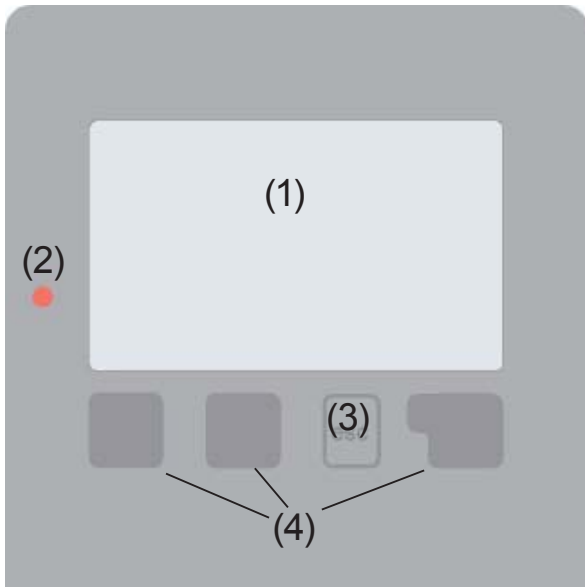

The display (1) shows graphic and text info on the hydraulic variant, set and measured values and other text info.

LED lamp (2):

lights up green - if a relay is closed and the controller works right

lights up red - if the controller is set to automatic operation and all relays are open

flashes slowly red - if manual operation mode is set

flashes quickly red - if an error occurred

Examples of display symbols:

pump (rotates in operation)



valve (direction of flow black)



collector



hot water storage tank



swimming pool



temperature sensor



heat exchanger



load pause



warning/error message



new information available



logging is active



Entries are made using four keys (3+4), which are assigned to different functions depending on the situation.

The "esc" key (3) is used to cancel an entry or to exit a menu.

If applicable there will be a request for confirmation as to whether the changes which have been made should be saved.

The function of each of the other three keys (4) is shown in the display line directly above the keys; the right-hand key generally has a selection and confirmation function.

Examples of key functions:

+/- = increase/decrease values

▼/▲ = scroll menu down/up

YES/NO = approve/reject

Info = additional information

Back = to previous screen

ok = confirm selection

Confirm = confirm setting

Operation

E.2 Commissioning help



The first time the controller is turned on, language and clock need to be set. After that a query appears as to whether you want to parameterize the controller using the Setup Wizard or not. The setup wizard can also be terminated or called up again at any time in the special functions menu. The setup wizard guides you through the necessary basic settings in the correct order, and provides brief descripti-

ons of each parameter in the display.

Pressing the “esc” key takes you back to the previous value so you can look at the selected setting again or adjust it if desired. Pressing the “esc” more than once takes you back step by step to the selection mode, thus cancelling the setup wizard. Finally, menu 3.2 under operating mode “Manual” should be used to test the switch outputs with the consumers connected, and to check the sensor values for plausibility. Then switch on automatic mode.

E.3 Free commissioning

If you decide not to use the commissioning help, you should make the necessary settings in the following sequence:

- Menu 9. Language (page 35)
- Menu 6.12 Time and date (page 32)
- Menu 6.1 Program selection (page 27)
- Menu 4. Settings, all values (page 20)
- Menu 5. Protective functions if modifications are necessary (page 24)
- Menu 6. Special functions if additional changes are necessary (page 27)

Finally, menu 3.2 under operating mode “Manual” should be used to test the switch outputs with the consumers connected, and to check the sensor values for plausibility. Then switch on automatic mode.



Caution

Observe the explanations for the individual parameters on the following pages, and check whether further settings are necessary for your application.

Operation

E.4 Menu structure

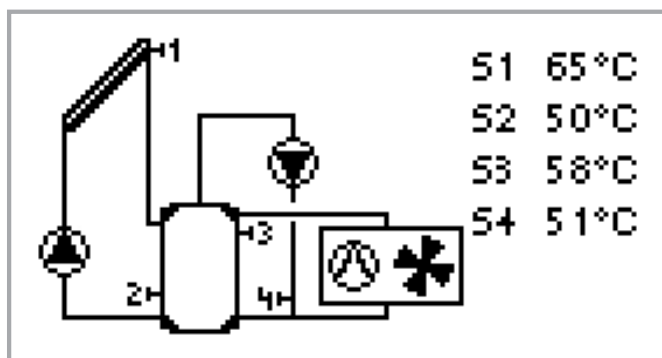

The graphics or overview mode appears when no key has been pressed for 2 minutes, or when the main menu is exited by pressing “esc”.

Pressing any key (4) in graphics or overview mode takes you directly to the main menu. The following menu items are then available for selection there:

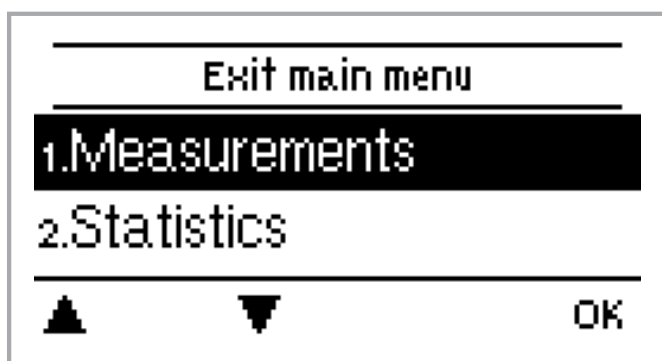

1. Measurements

Current temperature values with explanations

2. Statistics

Function control of the system with operating hours etc.

3. Operating mode

Automatic mode, manual mode or switch unit off

4. Settings

Set parameters needed for normal operation

5. Protections

Solar and frost protection, recooling...

6. Special functions

Commissioning help, program selection, sensor calibration, clock etc.

7. Menu lock

Menu lock against unintentional setting changes

8. Service Data

Diagnosis in the event of an error

9. Language

Language selection

Measurement values

1. - Measurements

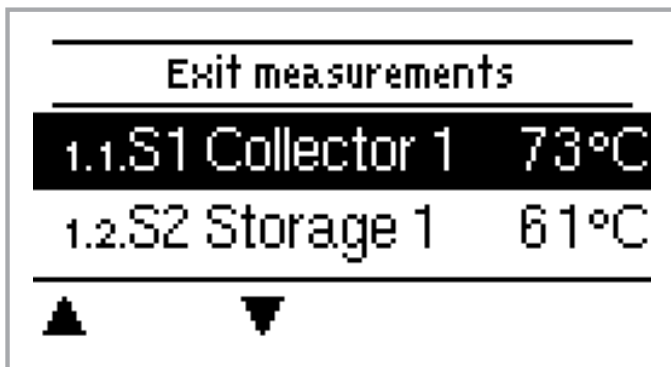

Menu “1. Measurements” serves to display the currently measured temperatures. What measurement values are displayed depends on the selected program and the specific controller model.

The menu is closed by pressing “esc” or selecting “Exit measurements”.



Caution

If “--” appears on the display instead of the measurement value, then there may be a defective temperature sensor or its wiring. If the cables are too long or the sensors are not placed optimally, the result may be small deviations in the measurement values. In this case the display values can be compensated for using the function of sensor compensation - see Chapter 6.8.

Which sensors are displayed will depend on the program selected, sensors connected and settings.

Statistics

2. - Statistics

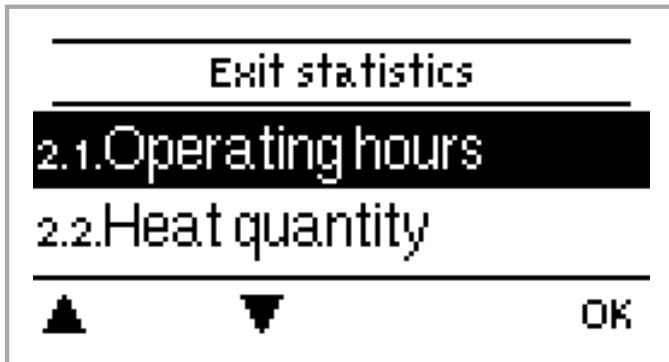

Menu "2. Statistics" is used for function control and long-term monitoring of the system.

The menu is closed by pressing "esc" or selecting "Exit statistics".



For analysis of the system data it is essential that time is set accurately on the controller. Please note that the clock does not continue to run if the mains voltage is interrupted, and must therefore be reset. Incorrect time set in the controller may result in data being deleted, recorded incorrectly or overwritten.

2.1. - Operating hours

Display of operating hours of the solar pump connected to the controller; various time spans are available (last day, week, month, year).

2.2. - Heat quantity

Display of the approximate heat output of the solar thermal system.

2.3. - Graphic overview

This function provides a clearly-organized display of operating hours, average ΔT and heat output as a bar graph. Various time ranges are available. The two left-hand keys can be used to page through the data.

2.4. - Error log

Display of the last 20 events occurring in the system with indication of date and time.

2.5. - Reset / Clear

Resetting and deleting the individual analyses. The function "All statistics" clears all analyses but not the error messages.

Operating modes

3. - Operating modes

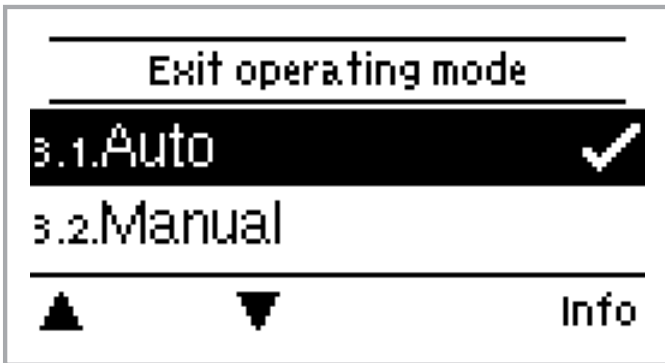

In menu “3. Operating modes” the controller can either be switched to automatic mode, turned off, or placed in a manual operating mode.

The menu is closed by pressing “esc” or selecting “Exit operating mode”.

3.1. - Automatic

Automatic mode is the normal operating mode of the controller.

Only automatic mode provides proper controller function taking into account the current temperatures and the parameters that have been set!

3.2. - Manual

The relay and thus the connected pump, valve or heating rod are switched on and off manually by pressing a key, with no regard to the current temperatures and the parameters which have been set. The measured temperatures are also shown.



Danger

The manual mode is intended to be used by a technician when commissioning or checking the system. Activating manual mode in current operation can lead to system damage or overheating of water in the hot water storage tank!

3.3. - Off



Warning

When the operating mode “Off” is activated, all controller functions are switched off. This can lead, for example, to overheating of the solar collector or other system components. The measured temperatures are displayed even when the controller is Off.

Never select other mode than automatic without a reason. Long-term operation in manual mode may lead to collector or storage tank overheating and limiting the lifetime of solar fluid and other solar thermal components!

Settings

4. - Settings

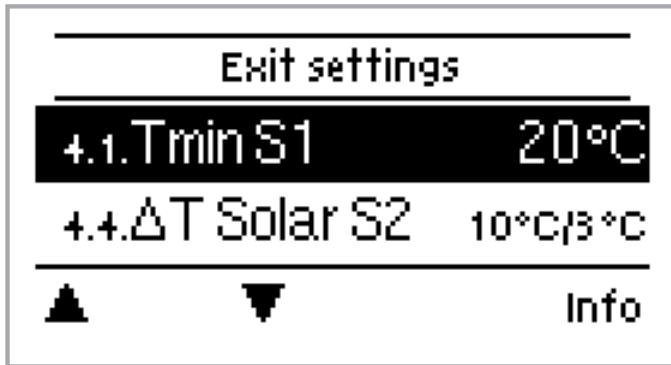

The system parameters are set in menu "4. Settings".

The menu is closed by pressing "esc" or selecting "Exit settings".

4.1. - Tmin S(X)

Sensor S(X) switch-on temperature

If the temperature at sensor S(X) exceeds the value of TminS(X) and the other conditions are also met, then the controller switches on the associated pump and/or valve. If the temperature at the sensor S (X) drops below the value of TminS(X) by 5 °C, then the pump and/or the valve are switched off again.

Setting range: 0-99 °C / Default setting: 20 °C

4.4. - ΔT Solar S(X)

Switch-on/switch-off temperature difference for sensor (X)

If this temperature difference between the reference sensors is exceeded and the other conditions are also met, then the controller switches on the applicable relay. When the temperature drops by ΔT Off, then the relay is switched off again.

Setting range: ΔT: 4 - 50 °C / ΔT off: 2 - 49 °C / Default setting: depends on the hydraulic variant



Caution

Setting the temperature difference too small may lead to a situation when the heat source will not be able to heat up the solar consumer to the value when the pump is switched off (ΔT of source – ΔT off). Then the pump will run continuously. Setting the temperature difference too big may lead to switching the circulation pump on and off permanently. Please refer to special rules described in Chapter 6.3 for switching pumps with controlled speed.

Settings

4.5. - Tmax S(X)

Sensor S(X) switch-off temperature

If the temperature at sensor S(X) exceeds the value of TmaxS(X) and the other conditions are also met, then the controller switches off the associated pump and/or valve. If the temperature at the sensor S(X) drops below this value, then the pump and/or the valve are switched on again.

Setting range: 0-99 °C / Default setting: 60 °C



Danger

Temperature values which are set high will allow higher solar heat accumulation but it shall be checked that all system components are resistant to high temperatures and scalding protection is provided. Regulus solar thermal systems are safe for heating water up to 95 °C.

Settings

4.14. - Auxiliary heating

Auxiliary heat function based on time or temperature.

4.14.1. - TH Set

Target temperature at thermostat sensor 1. Below this temperature, auxiliary heating is switched on, till TH set + hysteresis is reached.

Setting range: 0°C to 100 °C / Default setting: 50°C



Danger

Temperature values which are set too high can lead to scalding or damage to the system. Scalding protection must be provided by the customer!

4.14.2. - Hysteresis

Hysteresis of setpoint temperature. Setting range: 1 (highest priority) to 3 (lowest priority).

Setting range: -20 K to +20 K / Default setting: 10 K

4.14.3. - Aux. heat source sensor 1

TH set is measured with thermostat sensor 1 and compared to T set. When thermostat sensor 2 is also connected, the relay switches on when T set is undershot at thermostat sensor 1, and switches off when TH set + hysteresis at thermostat sensor 2 is exceeded.

4.14.4. - Aux. heat source sensor 2

Optional switch off sensor

When TH set + hysteresis is exceeded at the optional thermostat sensor 2, the relay is switched off.

4.14.5. - T eco

TH set in Energy saving mode.

Setting range: 0-100 °C / Default setting: 40 °C

4.14.6. - Energy saving mode

When Energy saving mode is active: During solar charge T eco is used instead of TH set. When the temperature drops below T eco at thermostat sensor 1, the relay is switched on and heats up to T eco + hysteresis.

Setting range: ON/OFF / Default setting: OFF

Settings

4.14.7. - Periods

Set the desired periods of time when the thermostat should be active. 2 periods can be set per day, settings can also be copied to other days. Outside the set times the auxiliary heat source is switched off.

Setting range: from 00:00 to 23:59 / Default setting: 06:00 to 22:00

4.15. - Recirculation

Time- and temperature controlled operation of hot water recirculation pump.

4.15.1. - Min. set temperature

If temperature at the hot water sensor drops below this temperature during the period when HW recirculation is active (see 4.15.7), the recirculation pump is switched on.

Setting range: 10 °C to 90 °C / Default setting: 51°C

4.15.2. - Hysteresis

Hysteresis of the preset temperature.

Setting range: 1 K to +20 K / Default setting: 5 K

4.15.7. - Recirculation time programs

Set the desired periods of time when recirculation should be active. 2 periods can be set per day, settings can also be copied to other days. Outside the set times recirculation is switched off.

Setting range: from 00:00 to 23:59 / Default setting: 06:00 to 22:00

Protective functions

5. - Protective functions

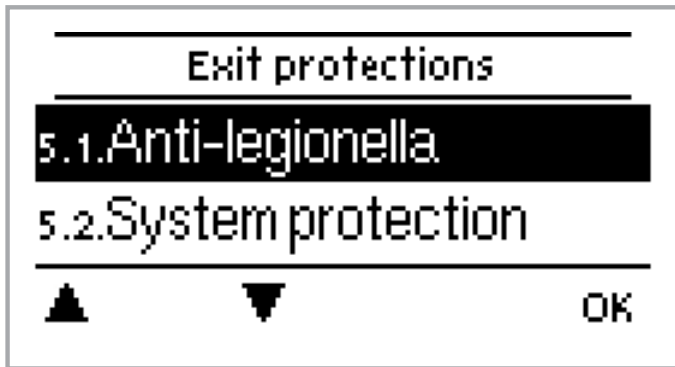

Menu "5. Protections" can be used to activate and set various protective functions.



This does not under any circumstances replace the safety facilities to be provided by the customer!

The menu is closed by pressing "esc" or selecting "Exit protections".

5.1. - Anti Legionella

This function is used to heat up the system during selected period (Min. time Legionella) that will start following the set time schedule and last until the temperature AL Tset is reached. This temperature must be reached and kept at the AL sensor for the time set as AL residence time. If the AL function is ON, then the parameter Tmax changes automatically to AL Tset +10 °C to prevent system switch off due to exceeding a high temperature limit.

Anti Legionella heat up is considered successful if the temperature at Legionella Sensor 2 reaches at least a temperature of "AL Tset" -5°C. The time of this heat up is then displayed as **Last AL heat**. If the temperature of "AL Tset" -5°C is not reached within 2 hours, the attempt will be cancelled and started again the following day. At the same time, an error message will appear. A message saying "Anti-Legionella heat up can be started manually" will be also displayed.

AL resid. time - This determines the time span for which the AL T set temperature must be detected for a successful AL heat up.

Last AL heat Displays the date and time of the last successful AL heat up.

AL-times During this periods the AL heat up is attempted.

Setting range: Anti Legionella: ON, OFF / Default setting: ON

Setting range: AL Tset 60 °C to 99 °C / Default setting: 70 °C

Setting range: AL resid. time 1 min. to 120 min. / Default setting: 15 min



Whenever heating-up has been carried out with the anti-Legionella function switched on, an information message with the date appears on the display.



During the anti-Legionella function the storage tank is heated up to a very high temperature which can lead to scalding and damage to the system.

Protective functions



Warning

This anti-Legionella function does not provide complete protection against Legionella, because the controller is dependent on sufficient energy being fed in, and it is not possible to monitor the temperatures in the entire range of the storage tanks and the connected piping system. To provide complete protection against Legionella bacteria, it must be ensured that the temperature is raised to the necessary temperature, and at the same time there must be water circulation in the storage tank and piping system by means of other additional energy sources and external control units.

5.2. - System protection

Protection of the highest priority

Protection of the solar circuit protects its components from overheating. If “**SP T on**” is exceeded at the collector for over 1 minute, the pump is switched off. The collector is left at high temperature. The pump is activated again when the temperature drops below “**SP T off**”.

Setting range: Solar circuit protection: ON, OFF / Default setting: ON

Setting range: SP T on 60 °C to 150 °C / Default setting: 120 °C

Setting range: SP T off 50 °C to SP T on – 5°C / Default setting: 115 °C



Warning

Collectors do not get cooled and stay heated. This may result in limited lifetime of the solar fluid. If you use this function, please check your solar fluid regularly!

5.3. - Collector protection

If “**CP T on**” is exceeded at the collector sensor, the pump is switched on in order to cool the collector down. The pump turns off when the collector temperature drops below “**CP T off**” or the temperature “**Storage (X) maximum**” is exceeded in the storage tank or swimming pool. In systems with 2 storage tanks only the lower-priority tank or pool is used for collector cooling.

Setting range: Collector protection: ON, OFF / Default setting: OFF

Setting range: CP T on 60 °C to 150 °C / Default setting: 110°C

Setting range: CP T off 50°C to to CP T on – 5 °C / Default setting: 100°C

Setting range: Storage (X) maximum 30 °C to 140 °C / Default setting: 90 °C

** (x) is the storage tank number*



Danger

When this function is active, a storage tank or swimming pool may get heated up to “Storage (X) maximum”, over Tmax S2 (see 4.2. - Tmax S) which might cause damage to the system.

5.4. - Recooling

At the end of a sunny day the temperature in a storage tank may easily reach high values. In order to prevent further temperature increase the next day, excess energy can be released into the air via collectors under cloudy conditions or after sunset.

Protective functions

If the temperature in the storage tank exceeds the value “**Recooling Tset**” and the collector is at least by 20 °C cooler than the storage tank, the solar pump starts. The storage tank is then cooled down until the “**Recooling Tset**” is reached.

Setting range: Recooling: ON, OFF / Default setting: OFF

Setting range: Recooling Tset: 0 °C to 99 °C / Default setting: 70 °C



Caution

This function enables to release excess heat from the storage tank considerably and without solar fluid overheating, via piping and collectors into the ambient air. It is recommended to keep activated.

5.5. - Frost protection

A two-stage frost protection function is available. In stage 1 the controller switches the pump on for 1 minute every hour if the collector temperature drops below the set value “**Frost level 1**”. If the collector temperature drops further to the set value “**Frost level 2**”, the controller switches the pump on continuously. If the collector temperature then exceeds the value “**Frost level 2**” by 2 °C, then the pump switches off again.

Setting range: Frost protection: ON, OFF / Default setting: OFF

Setting range: Frost level 1 -25 to 10 °C or OFF / Default setting: 7 °C

Setting range: Frost level 2 -25 to 8 °C or OFF / Default setting: 5 °C



Caution

This function causes energy loss via the collector!
As Regulus solar thermal systems are filled with antifreeze fluid, the antifreeze protection shall remain off.

5.6. - Seizing protection

Protection against pump seizing by regular short running of a pump or a valve. Seizing may occur after longer inactivity of valves or pumps. If the seizing protection is activated, the controller switches the relay in question and the connected appliance every day at 12:00 or weekly on Sundays at 12:00 (setting “weekly”) for 5 seconds in order to prevent the pump and/or the valve from sticking after an extended stationary period.

Setting range: ABS R1: daily, weekly OFF / Default setting: daily

Setting range: ABS R2: daily, weekly OFF / Default setting: daily

5.7. - Collector alarm

If this temperature is exceeded at the collector sensor when the solar pump is on, a warning is triggered. A red LED starts flashing and a warning message is shown on the display.

Setting range: Collector alarm OFF, ON / Default setting: OFF

Setting range: Collector Tmax 60 °C to 299 °C / Default setting: 115 °C

Setting range: Delay: 1 - 60 minut / Default setting: 1 min.

Special functions

6. - Special functions

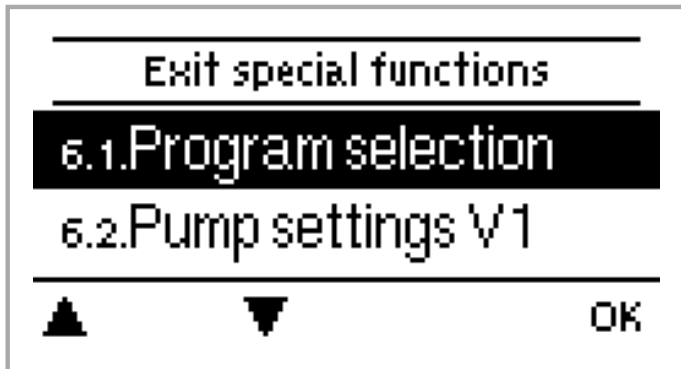

Menu “**6. Special functions**” is used to set basic items and expanded functions.



Time and Date is the only function to be set by the user. Other functions may be set by a specialist only.

The menu is closed by pressing “esc” or selecting “Exit special functions”.



Menu numbering depends on the hydraulic variant selected.

6.1. - Program selection

The suitable hydraulic variant for the specific application is selected and set here (see B.5 Hydraulic variants). The associated diagram is displayed on pressing “info”.

Setting range: 8 hydraulic variants / Default setting: Solar (selection 6.1.1)



Normally the program selection is made only once during initial commissioning by the specialist. Incorrect program selection can lead to unpredictable errors. If the program is changed, the settings revert to factory settings.

For hydraulic variants 6, 7 and 8, one extra Pt1000 temperature sensor is needed.

6.2. - Pump settings V1

This menu contains the settings for high-efficiency pumps with either 0-10V or PWM control.



Solar pumps perform at their highest power when the signal is at its maximum. Heating pumps on the other hand are set to the highest power when the control signal is at the lowest.

6.2.1. - Type of signal

Standard: Speed control for standard pumps.

0-10V: Speed control of a high efficiency pump by 0-10V signal.

PWM: Speed control of a high efficiency pump by PWM signal.

6.2.2. - Pump profile

In this menu, preconfigured profiles for various pumps can be selected.

Special functions

6.2.3. - Output Signal

This menu determines the type of pump used: Solar pumps perform at their highest power when the signal is also at its maximum, heating pump on the other hand are set to highest power when the control signal is at its minimum.

Solar = Normal, Heating pumps = Inverted.

Setting range: Normal, Inverted / Default setting: Normal

6.2.4. - PWM Off / 0-10V Off

This signal is put out when the pump is switched off (pumps that can detect cable break need a minimum voltage).

Setting range: Solar: 0 to 50 % / Default setting: 0 %

HP: 50 to 100 % / Default setting: 100 %

6.2.5. - PWM Zap / 0-10V Zap

This signal is needed to turn the pump on at minimum speed.

Setting range: Solar: 0 to 50 % / Default setting: 10 %

HP: 50 to 100 % / Default setting: 90 %

6.2.6. - PWM Max / 0-10V Max

This determines the output voltage for the maximum performance of the pump that is used e.g. during purging or manual operation.

Setting range: Solar: 50 to 100 % / Default setting: 100 %

HP: 0 to 50 % / Default setting: 0 %

6.2.7. - Show signal

Displays the set signal in text and a graphical diagram.

Special functions

6.3. - Speed control R1

6.3.1. - Modes R1

Off: There is no speed control. The connected pump is only switched on or off with full speed.

Mode M1: Control to the set ΔT , starting from max. speed:

After the purging time the controller switches to the set max. speed. If the temperature difference ΔT between the reference sensors (collector and storage tank) is less than the set value, then the speed is decreased by one stage after the sweep time elapses. If the temperature difference between the reference sensors is greater than the set value, then the speed is increased by one stage after the sweep time elapses. If the controller has adjusted the speed of the pump down to the smallest stage and the ΔT between the reference sensors is ΔT off, the pump is switched off.

Mode M2: Control to the set ΔT , starting from min. speed:

After the purging time the controller switches to the set min. speed. If the temperature difference ΔT between the reference sensors (collector and storage tank) is greater than the set value, then the speed is increased by one stage after the sweep time elapses. If the temperature difference ΔT between the reference sensors is below the set value, then the speed is decreased by one stage after the sweep time elapses. If the controller has adjusted the speed of the pump down to the smallest stage and the ΔT between the reference sensors is $T\Delta$ off, the pump is switched off.

Mode M3: Control to constant collector temperature, starting from min. speed:

After the purging time the controller switches to the set min. speed.

If the temperature at the collector sensor (or the respective R2 relay in variants with a heat exchanger) is greater than the setpoint, then the speed is increased after the sweep time expires.

If the temperature at the reference sensor (collector) is less than the setpoint, then the speed is decreased after the sweep time expires.

Mode M4: When the primary storage is loaded, speed control works as in M3.

When the secondary storage is loaded, speed control works as in M2.

Setting range: M1, M2, M3, M4, off/Default setting: off

6.3.2. - Purging time

During this time period, the pump is running with full speed (100%) to ensure trouble-free startup. After this time has passed, the pump is set to speed control and is set to max. speed or min speed, depending on the speed control mode (M1-M4) chosen.

Setting range: Purging time 5-600 sec. /Default setting: 8 sec.

6.3.3. - Sweep time

Sweep time determines the inertia of the speed control to prevent quick fluctuations in speed and subsequently also big fluctuations in temperature.

Setting range: Sweep time 1-15 min. /Default setting: 4 min.

Special functions

6.3.4. - Max.speed

The maximum speed of the pump is specified here.

Setting range: 15-100% / Default setting: 100%



The indicated percentages are guide values that may vary to a greater or lesser extent depending on the system, pump and pump stage.

6.3.5. - Min. speed

The minimum speed of the pump at relay R1 is specified here.

Setting range: 10 % to 95 % / Default setting: 30 %



The indicated percentages are guide values that may vary to a greater or lesser extent depending on the system, pump model and pump stage. 100% is the maximum possible voltage/frequency of the controller.

6.3.6. - Setpoint

This value is the control setpoint for Mode M3 (see 6.3.1. - Modes). If the value at the collector sensor drops below this, the speed is reduced. If it rises above this, the speed is increased.

Setting range: 0 to 90 °C / Default setting: 60 °C

6.3.7. - Temperature difference

This value is an adjustable temperature difference for Modes M1 and M2 (see 6.3.1 - Modes). If the measured temperature difference ΔT between reference sensors is lower than this value, the speed is reduced. If it is higher, the speed is increased.

Setting range: 3-50 K / Default setting: 10 K

6.7. - Heat quantity

When the heat meter mode “Constant flow rate” is selected, an approximated heat quantity is calculated using the values the user has to enter. These are type of glycol/antifreeze, glycol portion and flow rate. These values are put into correlation with the temperature data of selected sensors.

(choice in 6.7.5, 6.7.6 and 6.7.7).



The heat quantity measured in the mode “Constant flow rate” is a calculated approximation for function control of the system.

6.7.1 - Heat metering

This function turns heat metering on and off.

Setting range: ON, OFF / Default setting: OFF

6.7.5 - Antifreeze type

Set the type of anti freeze used.

Setting range: Etylen, Propylen / Default setting: Etylen

Special functions

6.7.6. – Glycol percentage

Concentration of antifreeze used in the system, in %.

Setting range: 0 % - 60 % / Default setting: 40 %

6.7.7. - Flow rate

This determines the flow rate in litres per minute that is used for the calculation of the heat quantity.

Setting range: 0 l/min. - 100 l/min. / Default setting: 5 l/min.

6.7.9. - ΔT Offset

Since for the heat meter the collector and the storage temperature are used, a difference to the flow respectively return flow temperature can be compensated by changing ΔT Offset accordingly.

Example: *Displayed collector temp. 40 °C, measured flow temperature 39 °C, displayed storage temperature 30 °C, measured return temperature 31 °C = results in a correction value of -20 % (displayed ΔT 10 K, real ΔT 8 K = -20 % correction)*

Setting range: -50 % to +50 % / Default setting: 0 %

6.8. - Sensor calibration

Deviations in the temperature values displayed, for example due to cables which are too long or sensors which are not positioned optimally, can be compensated for manually here. The settings can be made for each individual sensor (S1 to S4) in steps of 0.5 °C (temperature) resp. 0.2 % of the measuring range of the VFS sensor per step.

Setting range: -100 to +100 (-50°C to +50°C) / Default setting: 0



Caution

These settings are only necessary in special cases at the time of initial commissioning and may be done by a specialist only. Incorrect settings may lead to an error.

6.9. - Commissioning

Starting the Setup Wizard guides you in the correct order through the basic settings necessary for commissioning, and provides brief descriptions of each parameter in the display.

Pressing the “esc” key takes you back to the previous value so you can look at the selected setting again or adjust it if desired. Pressing the “esc” more than once takes you back step by step to the selection mode, thus cancelling the commissioning help.



Caution

May only be started by a specialist during commissioning! Observe the explanations for the individual parameters in these instructions, and check if further settings are necessary for your application.

6.10. - Factory settings

All of the settings that have been made can be reset, thus returning the controller to its delivery state.

Special functions



Caution

The entire parameterization, analyses, etc. of the controller will be lost irrevocably. The controller must then be commissioned and set once again.

6.11. - Starting aid function

With some solar thermal systems, namely with evacuated tube collectors, it may occur that measurement at the collector sensor takes too long or is not quite precise, which is often caused by the sensor not being placed at the hottest location. When the start aid function is activated, the following is carried out:

If the temperature at the collector sensor increases by the value specified under „Increase” within one minute, then the solar pump is switched on for the set ”Purging time” so that the medium to be measured can be moved to the collector sensor. If this still does not result in a normal switch-on condition, then the start aid function is subject to a 5-minute lockout time.

Starting aid setting range: on, off/Default setting: off

Purging time setting range: 2 - 30 s /Default setting: 5 s

Increase setting range: 1 °C -10 °C/Default setting: 3 °C/min.



Caution

This function should only be activated by a specialist if problems arise with acquisition of measurement values. In particular follow the instructions from the collector manufacturer.

6.12. - Time & date

This menu is used to set the current time and date.



Caution

For a proper operation of the controller and analysis of the system data it is essential for the time to be set accurately on the controller. Please note that if the mains voltage is interrupted the clock continues to run for 24 hours and then stops and needs to be reset after that.

6.13. - Daylight saving time

When this function is active, the controller’s clock changes automatically to and from DST (DST, Daylight Saving Time).

Setting range: on, off/Default setting: on

6.14. - Sleep mode

When active, the displays backlight is switched off after 2 minutes of inactivity.

6.15. - Temperature unit

This menu is used to select the temperature unit that is displayed.

Setting range: °F or °C /Default setting: °C

Menu lock

7. - Menu lock

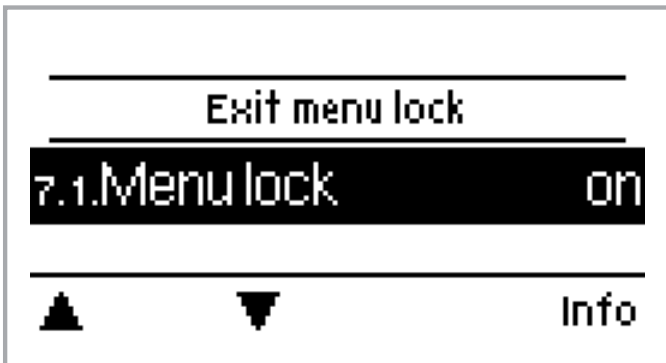

Menu “7. Menu lock” can be used to secure the controller against unintentional changing of the set values.

The menu is closed by pressing “esc” or selecting “Exit menu lock”.

The menus listed below remain completely accessible despite the menu lock being activated, and can be used to make adjustments if necessary:

1. Measurement values
2. Statistics
- 6.12 Time&date
7. Menu lock
8. Service values

To lock the other menus, select “Menu lock on”. To enable the menus again, select “Menu lock off”.

Setting range: on, off /Default setting: off

Service values

8. - Service values

The menu “9. Service values” can be used for remote diagnosis by a specialist in the event of an error etc.



Caution

Note down data at the time when an alarm or error occurs, e.g. into the following table.

The menu can be closed at any time by pressing “esc”.

8.1	
8.2	
8.3	
8.4	
8.5	
8.6	
8.7	
8.8	
8.9	
8.10	
8.11	
8.12	
8.13	
8.14	
8.15	
8.16	
8.17	
8.18	
8.19	
8.20	
8.21	
8.22	
8.23	
8.24	
8.25	
8.26	
8.27	
8.28	
8.29	
8.30	

8.31	
8.32	
8.33	
8.34	
8.35	
8.36	
8.37	
8.38	
8.39	
8.40	
8.41	
8.42	
8.43	
8.44	
8.45	
8.46	
8.47	
8.48	
8.49	
8.50	
8.51	
8.52	
8.53	
8.54	
8.55	
8.56	
8.57	
8.58	
8.59	
8.60	

Language

9. - Language

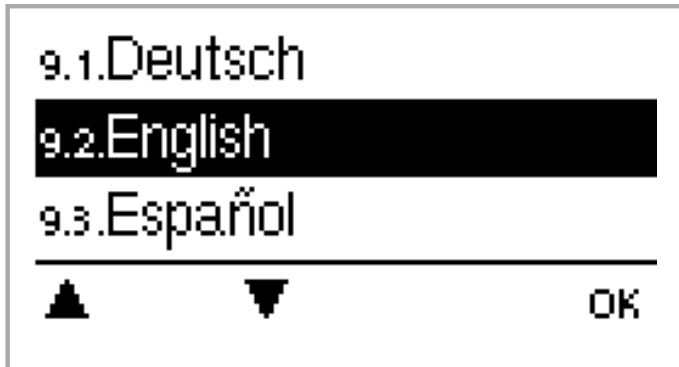

Menu “9. Language” can be used to select the language for the menu guidance. This is queried automatically during initial commissioning.

Malfunctions

Z.1 Malfunctions with error messages

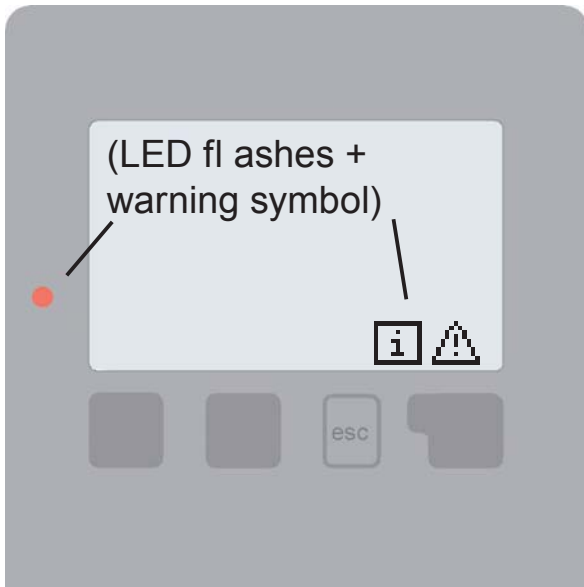

If the controller detects a malfunction, the red light flashes and the warning symbol also appears in the display. If the error is no longer present, the warning symbol changes to an info symbol and the red light no longer flashes.

To obtain more detailed information on the error, press the key under the warning or info symbol.



Consult a specialist in the event of an error!

Possible error messages:

Sensor x defective ----->

Notes for the specialist:

Means that either the sensor, the sensor input at the controller or the connecting cable is defective. (Resistance table see chap. B.2)

Collector alarm ----->

Means that the collector has risen above the temperature set in 5.7.

Restart ----->

Means that the controller was restarted, for example due to a power failure. Check the date&time!

Night circulation ----->

Means that the solar pump is/was in operation between 23:00 and 04:00.

Malfunctions

Z.2 Replacing the fuse



Repairs and maintenance may only be performed by a specialist. Before working on the unit, switch off the power supply and secure it against being switched on again! Check for the absence of power!



Only use the supplied spare fuse or a fuse of the same design with the following specifications: T2A 250V.

Z.2.1

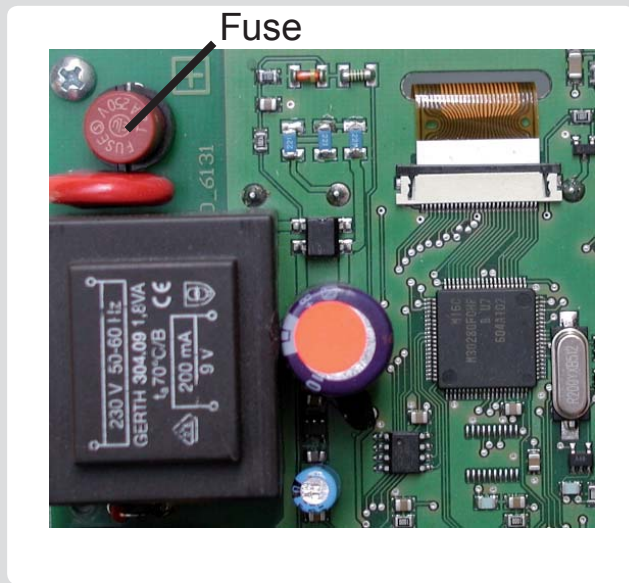

If the mains voltage is switched on and the controller still does not function or display anything, then the internal device fuse may be defective. In that case, disconnect the device, open it, remove the old fuse and check it. Replace the defective fuse with a new one, locate the external source of the error (e.g. pump) and replace it. Then first re-commission the controller and check the function of the switch outputs in manual mode as described in Chap. 3.2.

Z.3 Maintenance



In the course of the general annual maintenance of your heating system you should also have the functions of the controller checked by a specialist and have the settings optimized if necessary.

Performing maintenance:

- Check the date and time (see 6.12)
- Assess/check plausibility of analyses (see Chap. 2)
- Check the error log (see Chap. 2.4.)
- Verify/check plausibility of the current measurement values (see Chap. 1)
- Check the switch outputs/consumers in manual mode (see Chap. 3.2)
- If needed, optimize the parameter settings

Useful hints and tricks

Instead of setting the flow rate for the system using a flow rate limiter, it is better to adjust the flow rate using the switch on the pump and by means of the “Max. speed” setting on the controller (see 6.3.4.Max. speed). This saves electricity!

The service values (see 8) include not only current measurement values and operating states, but also all of the settings for the controller. Write the service values down once commissioning has been successfully completed.

In the event of uncertainty as to the control response or malfunctions the service values are a proven and successful method for remote diagnosis. Write the service values down (see 8) at the time when the suspected malfunction occurs. Send the service value table by fax or e-mail with a brief description of the error to the specialist.

In a system with a swimming pool, the pool can be easily switched off (e.g. for the winter) using a simple function. Just press and hold the “esc” key for several seconds while the system is displayed. As soon as the pool is switched off or on, the respective information will be displayed.

It is recommended to record any analyses and data that are particularly important to you at regular intervals.



REGULUS spol. s r.o.

Do Koutů 1897/3

143 00 Praha 4

CZECH REPUBLIC

<http://www.regulus.eu>

E-mail: sales@regulus.eu