

Regulus

www.regulus.eu

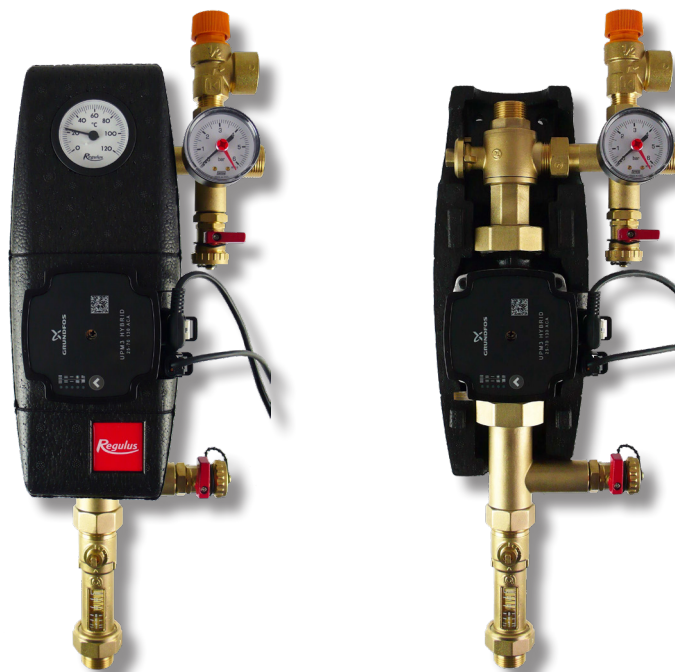

CSE1 SOL G P

Installation and Operation Manual
CSE1 SOL G P SOLAR PUMP STATION

EN

CSE1 SOL G P

1. Introduction

Thanks to its design, CSE1 SOL G P solar pump station enables a simple and quick connection into a solar circuit. It is fitted with a high-efficiency solar pump of the latest generation that permits continuous flow control.

This pump station is intended for controllers with PWM control or with 230 V switching (ON/OFF).

2. Pump Station Description

Main Features	
Application	This single-line solar pump station contains all components (except for a controller) necessary for current and efficient operation.
Description	The pump station consists of a UPM3 Hybrid 25-70 pump, check and safety valves, 2 ball valves, flow indicator, pressure gauge, thermometer, installation kit and insulation. The pump station further involves: <ul style="list-style-type: none">• connection point for an expansion vessel• safety valve outlet• ball valves for filling, draining and topping up a solar thermal system
Installation	on a tank or wall
Working fluid	water-glycol mixture (max. 1:1)

Codes corresponding to connection sizes		
Connection	G 3/4" M	G 1" M
Flow measurement range	2-12 l/min	8-28 l/min
Code	19987	19984

3. Pump Station Data

Data for CSE1 SOL G P Pump Station	
Max. fluid working temperature	110 °C
Max. working pressure	6 bar
Power supply	230 V, 50 Hz
IP rating	IP20
Ambient temperature	5 - 40 °C
Max. relative humidity	85 % at 25 °C
Insulation material	EPP RG 60 g/l
Overall dimensions (H x W x D)	510 x 195 x 155 mm
Total weight	4.4 kg

Min. values of working pressure*	
Values of min. working pressure at the pump suction port depending on temperature	0.8 bar at 50 °C 1.2 bar at 90 °C 1.8 bar at 110 °C

* this condition is met for current installations when the initial system pressure is set following the formula (see the Instructions for solar collectors): $p = 1,3 + 0,1 \cdot h$ [bar], where h... is the height from pressure gauge to the middle of collector array [m]

3.1 Pressure drop diagram

G 3/4" M connection - code 19987

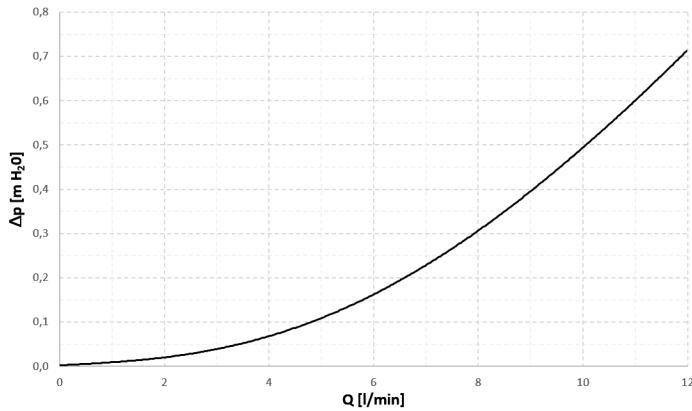

G 1" M connection - code 19984

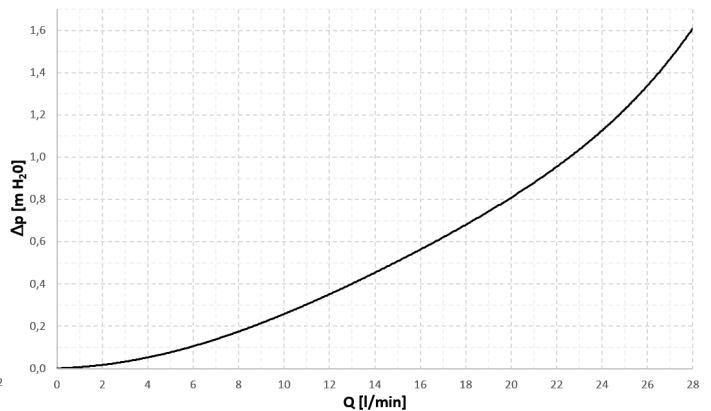

4. Pump Station Components

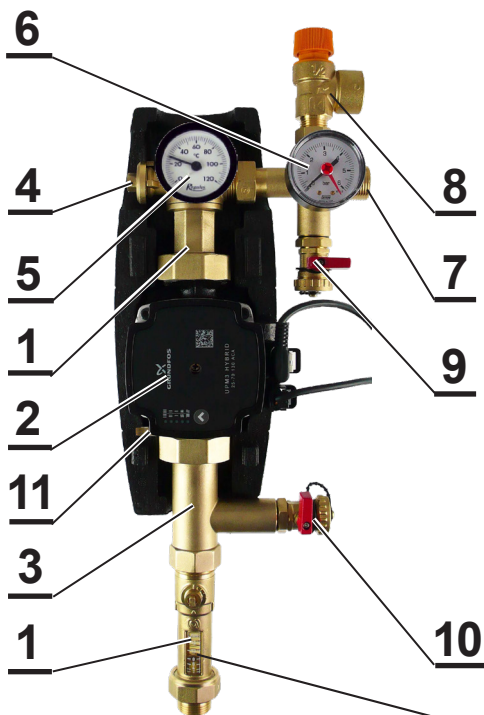

- 1 - FLOWRATE INDICATOR W. BALL VALVE
- 2 - CIRCULATION PUMP
- 3 - CHECK VALVE
- 4 - BALL VALVE W. SIDE OUTLET FOR SAFETY GROUP
- 5 - THERMOMETER (IN THE UPPER PART OF INSULATION)
- 6 - PRESSURE GAUGE
- 7 - EXPANSION VESSEL CONNECTION POINT, 3/4" M
- 8 - 6 BAR SAFETY VALVE
- 9 - 3/4" M FILL/DRAIN BALL VALVE
- 10 - 3/4" M FILL/DRAIN BALL VALVE
- 11 - SPANNER FOR CONTROL OF BALL VALVE

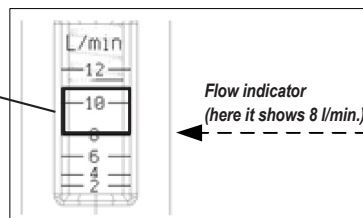

Flow indicator:
When reading the flow rate, the value at the lower edge of the sliding indicator applies (see fig.).

4.1 Check valve

The check valve prevents the tank from cooling down due to gravity circulation when the sun is not shining. It is located between the ball valves and can therefore be removed and cleaned without having to drain the solar fluid from the entire circuit.

4.2 Ball valves

Ball valves are used to separate the pump station from the solar circuit. During servicing (including cleaning of the check valve) there is no need to drain the fluid from the solar system. For greater rigidity of the hydraulic part of the pump station, the upper ball valve is attached to the fixing back plate.

The upper ball valve is operated by a lever which is not located on the valve during operation. A spanner or pliers must be used to operate the lower ball valve, which is part of the flow indicator. Turning the lever or the spanner or pliers a quarter turn to the right closes the ball valve. It opens when the lever is turned to the left. Before closing / opening the ball valve, it is necessary to remove the top part of the insulation. As a result, closing the system is reserved for installation or service technicians only. Thus, the user cannot simply close the solar circuit and cause stagnation and subsequent degradation of the solar fluid.

The ball valves are equipped with a packing with two O-rings with dimensions of 8.7x1.8 mm that can be easily replaced by removing the control element with stop ends and loosening the packing nut with a # 21 spanner.

WARNING! IMPORTANT!

The safety valve, expansion vessel and upper fill/drain ball valve always remain connected to the solar thermal system, even if the ball valves are closed! For this reason, never try to separate them from the filled solar system, as there is a risk of serious injury and damage to the solar system!

Never close the drain line of the safety valve, it must always be free for any liquid leaking from the safety valve!

5. Installation Options

The solar pump station is designed to be mounted on a wall or a tank. In the rear section of the insulation there are four mounting holes with 160 mm vertical pitch.



OPENINGS IN THE REAR INSULATION SECTION FOR MOUNTING THE PUMP STATION

Contents of the mounting kit included in supply:

- for wall mount:
 - 2 dowels, 8 TX
 - 2 truss head screw, 5x50
- for tank mount:
 - 2 socket hex pan-head screw, M6x25

6. Pump Station Connection Diagram

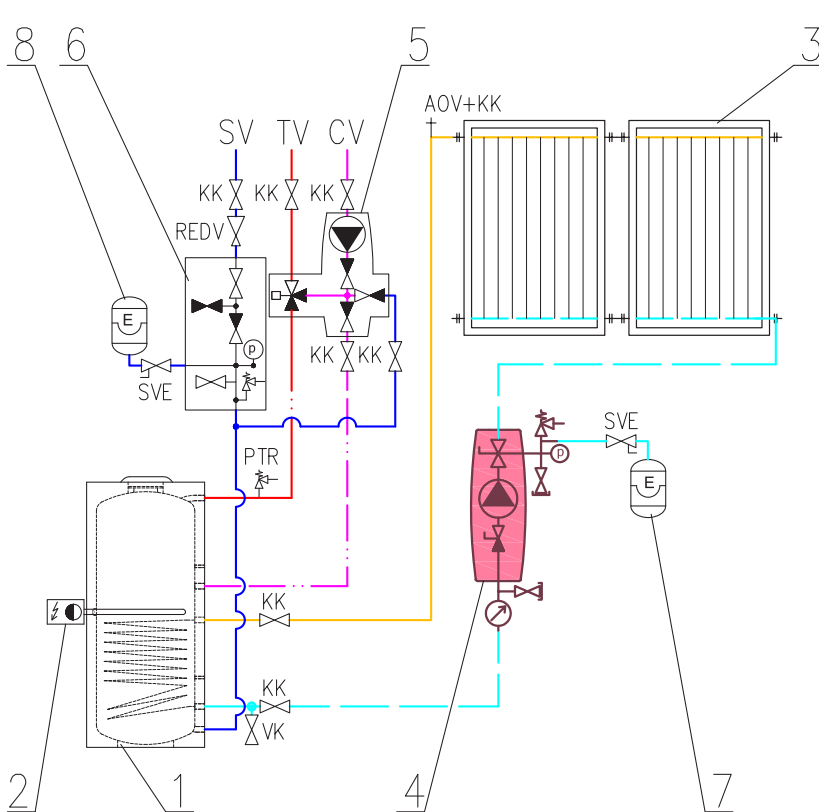

KEY

- 1 – hot water storage tank
- 2 – el. heating element w. thermostat
- 3 – solar collectors
- 4 – CSE1 SOL solar pump station**
- 5 – pump station for DHW recirculation – CSE TVMIX ZV
- 6 – safety kit for HW storage tank
- 7 – solar expansion vessel
- 8 – DHW expansion vessel

- SV – cold water
- TV – hot water
- CV – hot water recirculation

- KK – ball valve
- ZV – check valve
- AOV – automatic air vent valve
- PTR – pressure temperature relief valve
- REDV – pressure reducing valve (optional)
- VK – drain valve
- SVE – expansion vessel service valve

7. UPM3 HYBRID 25-70 Pump

Pump Control

The circulation pump can be controlled:



- internally without PWM signal by selecting a constant pressure or constant speed mode and a desired pump curve.
- by an external PWM C control signal (profile for use in solar thermal systems)

WARNING – IMPORTANT

The pump permits to be controlled also by PWM A signal (profile for use in heating systems). This mode must not be used for solar thermal systems. Using the PWM A pump profile would cause system damage. Using the proportional pressure mode in the internal pump control is also not advisable

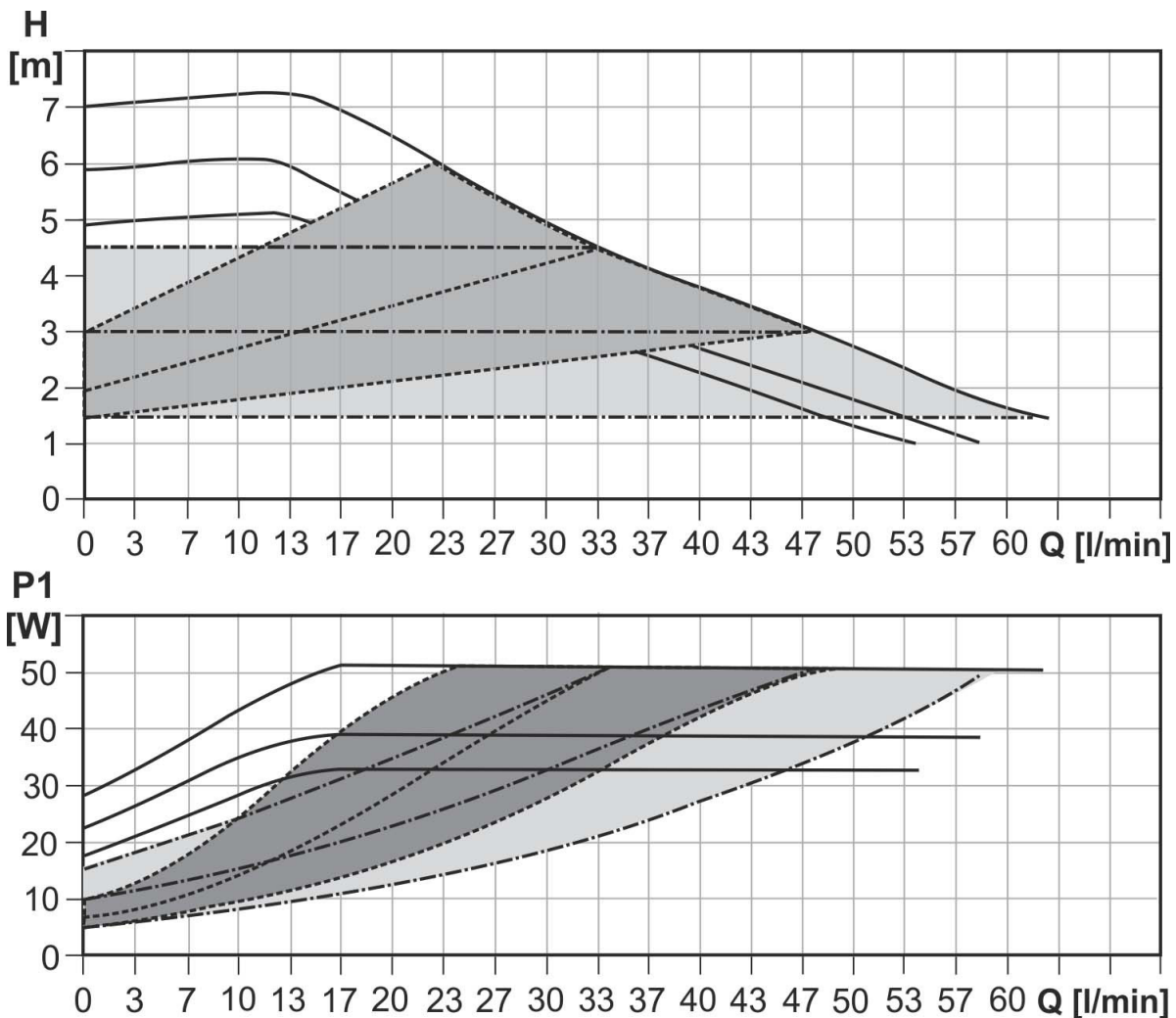
Performance Curves



Line type	Description
	Constant speed
	Proportional pressure
	Constant pressure

Description of Pump Profiles

a) INTERNAL CONTROL - Proportional pressure

- Head (pressure): reduced with growing system pressure drop and increased with sinking system pressure drop.



- Pump operating point: moves up or down on the selected proportional pressure curve depending on the current system pressure drop.
- Using the proportional pressure mode for solar thermal systems is not advisable.

CONTROL MODE		DESCRIPTION
Proportional pressure	I	The lowest curve of proportional pressure
	II	The middle curve of proportional pressure
	III	The highest curve of proportional pressure
	AUTO _{ADAPT}	Automatically controls performance in the range from the highest to the lowest proportional pressure curve. AUTO _{ADAPT} mode mode is not used for solar thermal systems.

b) INTERNAL CONTROL - Constant pressure

- Head (pressure): kept constant, disregarded of the system pressure drop
- Pump operating point: moves on the selected constant pressure curve depending on the current system pressure drop.



CONTROL MODE		DESCRIPTION
Constant pressure	I	The lowest curve of constant pressure
	II	The middle curve of constant pressure
	III	The highest curve of constant pressure
	AUTO _{ADAPT}	Automatically controls performance in the range from the highest to the lowest constant pressure curve. AUTO _{ADAPT} mode mode is not used for solar thermal systems.

c) INTERNAL CONTROL - Constant speed

- The pump runs at constant speed.
- Pump operating point: moves up or down on the selected constant curve depending on the current system pressure drop.



CONTROL MODE	Max. H (upper graph)	Max. P ₁ (lower graph)	
Konstantní otáčky	I	5 m	33 W
	II	6 m	39 W
	III	7 m	52 W

d) EXTERNAL CONTROL - PWM C (solar)

- The pump runs up to the max. head following the constant speed curve set depending on the current PWM value.
- The speed will increase with the increase of the PWM value. If PWM equals 0, the pump stops.



e) EXTERNAL CONTROL - PWM A (heating)

WARNING – IT IS PROHIBITED TO USE PWM A PUMP PROFILES

Using the PWM A (I, II, III) pump profiles in a solar pump station would cause system damage.

Settings Display

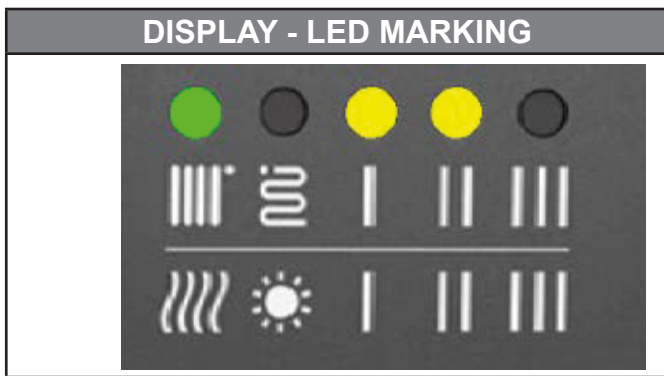

The LED marking is further omitted for better clarity.

DISPLAY		CONTROL MODE	
green LED NOT FLASHING		INTERNAL	
1		Proportional pressure AUTO _{ADAPT} - not used for solar thermal systems	
2		Constant pressure AUTO _{ADAPT} - not used for solar thermal systems	
3		Proportional pressure - not used for solar thermal systems	I
4			II
5			III
6		Constant pressure	I
7			II
8			III
9		Constant speed	I
10			II
11			III

DISPLAY		CONTROL MODE	
green LED FLASHING		EXTERNAL	
12		PWM C	
13		PWM A	I
14			II
15			III
			WARNING - DO NOT USE THESE MODES

GREEN LEDS FLASHING FREQUENCY	CONTROL	PWM SIGNAL RECEPTION
Not flashing	Internal	-
1 flash per second	External	NO
12 flashes per second	External	YES

WARNING: LEDs may be turned by 90° or 180°, or mirrored, depending on the specific pump type. When switched on, the pump runs at factory settings or the last setting. The display shows the current pump performance.

Setting selection

To select your desired setting, press the button repeatedly until you find the setting you need (see the table above). If you pass the desired setting, you have to go one more round until it appears again. The order of modes corresponds to the table.

Error display

DISPLAY	CONTROL MODE
	Seized pump
	Too low power supply voltage
	Electric fault

Pump wiring

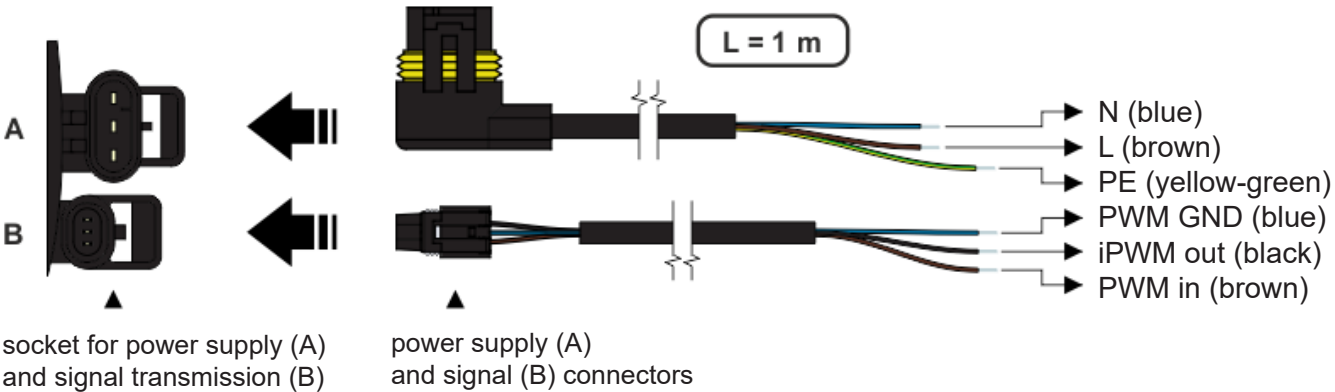

8. Filling a Solar Thermal System

For filling a solar thermal system, the ball valve above the pump must be closed and the ball valve below the pump open. The ball valve above the pump is operated by means of a lever which is not present on the ball valve during operation. Connect the filling pump to the fill and drain ball valves using hoses – see Chap. 4, and open these valves.

Prior to commissioning the system, both the ball valves must be open!

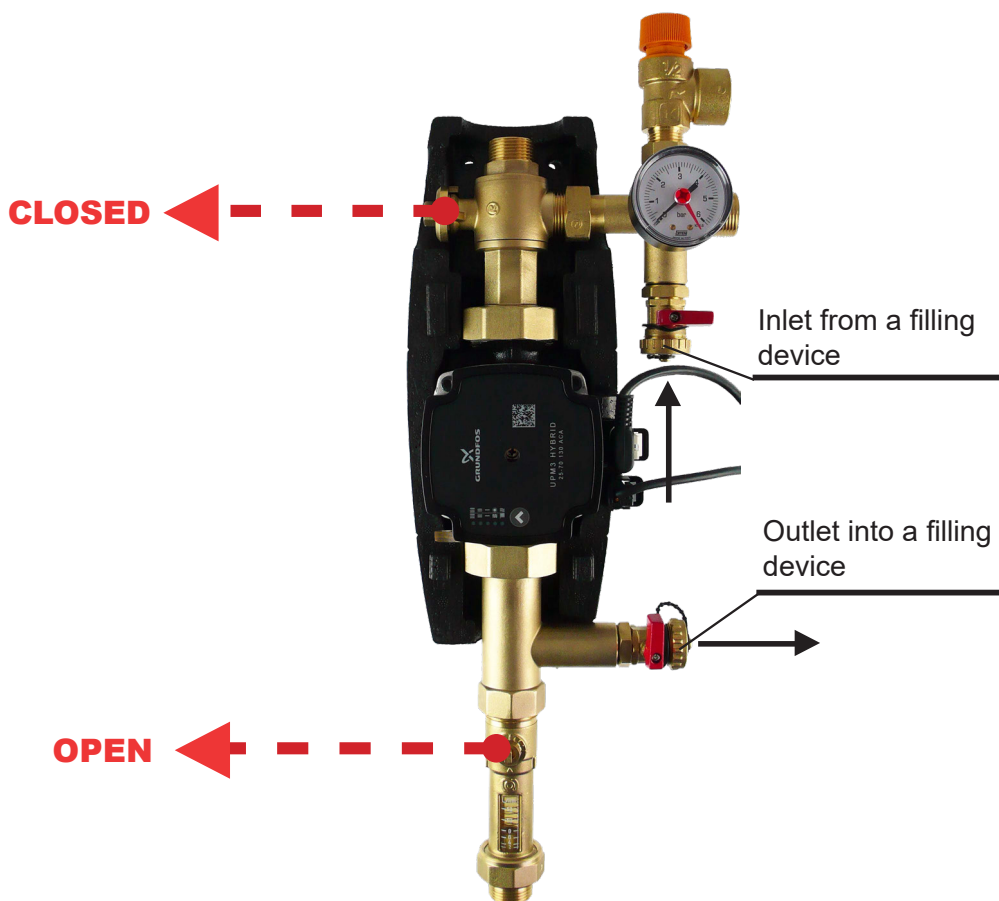

9. Solar System Air Venting

- During operation of the filling pump, close the drain valve and increase the pressure to about 5 bar;
- close the filling valve and turn off the filling pump, open the ball valve above the pump, do not disconnect the filling pump hoses!
- Set the circulation pump to the highest level and, by turning it on and off several times, vent the system using the automatic air vent valves, if they are installed in the system (the de-aerated pump works almost silently);
- continuously monitor the system pressure and if it drops, increase it to 5 bar by turning on the filling pump and opening the filling valve;
- repeat the venting until the float of the flow indicator takes a stable position during pump operation, shows a measurable flow and no bubbles appear in the sight glass. Then let the circulation pump run for at least 5 minutes;
- if an automatic venting valve(s) is (are) anywhere in the solar circuit, also close this valve after venting.

After filling and air venting the solar thermal system, close the fill and drain ball valves, adjust the system pressure to the required value, disconnect the hoses of the filling pump and check that both the ball valves above and under the pump are open!

