

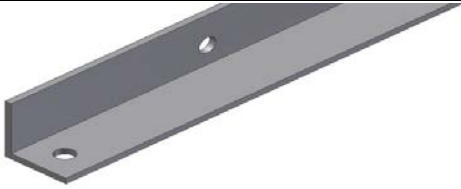







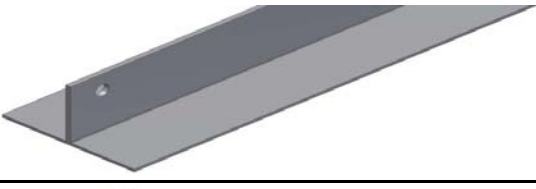
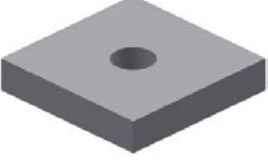

Držák pro sluneční kolektor KPG1H na ležato

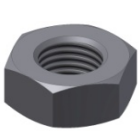
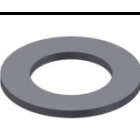
/ Support bracket for KPG1H solar collector, for horizontal installations

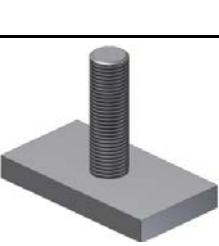
Na stěnu - trojúhelníková podpěra 15° kód 14792 / Wall mount triangle bracke 15° code 14792

| Obrázek Fig. | Označení Name | Rozměr Dimensions | Množství Qty | Kód dílu Code |
|---|---|---|-----------------------|------------------|
|  | Profil "L" 30x30x3 - hliník / L-beam 30x30x3 in aluminum | Délka 1124 mm / Length 1124 mm | 1 ks / 1 piece | 9470 |
|  | Profil základní "H"- hliník / Basic H-beam in aluminum | Délka 322 mm / Length 322 mm | 1 ks / 1 piece | 6949 |
|  | Profil základní "T" č.12197 - hliník / T-beam no.12197 in aluminium | Délka 1122 mm / Length 1122 mm | 1 ks / 1 piece | 9469 |
|  | Podložka držáku Al / Square washer for collector support, aluminum | 32x32 tl. 8 mm / 32x32, 8 mm thick | 2 ks / 2 pcs | 9405 |
|  | Šroub M8x45 nerez (imbus) DIN 912/A2 / Socket screw M8x45, stainless steel DIN 912/A2 | M8x45 | 2 ks / 2 pcs | 9564 |
|  | Šroub M8x16 nerez (imbus) DIN 912/A2 / Socket screw M8x16, stainless steel DIN 912/A2 | M8x16 | 1 ks / 1 piece | 6926 |
|  | Matice M8 nerez DIN 934/A2 / M8 Hex nut, stainless steel DIN 934/A2 | M8 | 5 ks / 5 pcs | 8381 |
|  | Podložka 8,4 nerez DIN 125/A2 / 8.4 Flat washer, stainless steel DIN 125/A2 | pr.8,4 mm / diam. 8.4 mm | 3 ks / 3 pcs | 7256 |
|  | Podložka vějířová - vnější ozubení 8,4 DIN 6798 A/A2 nerez / Serrated tooth washer, 8.4, DIN6798 A/A2, stainless steel | pr.8,4 mm / diam. 8.4 mm | 5 ks / 5 pcs | 8382 |
|  | Šroub M8x30 velká hlava pro základní profil / M8x30 bolt with big T head, for H-beam | M8x30 | 2 ks / 2 pcs | 8369 |
|  | Krytka H profilu / H-rail end plug | | 1 ks / 1 piece | 11773 |
|  | Vrut 8x75 nerez (6hr. hlava) DIN 571/A2 / 8x75 Lag bolt, stainless steel, DIN 571/A2 | pr.8x75 mm / diam. 8x75 mm | 5 ks / 5 pcs | 12787 |
|  | Podložka 8,4 (velká 3d) nerez DIN 9021/A2 / Washer 8.4 (large diam. 3d), stainless steel, DIN 9021/A2 | pr.8,4 mm / diam. 8.4 mm | 5 ks / 5 pcs | 7008 |
|  | Hmoždinka pr. 12 / Dowel, 12mm | pr.12 mm / diam. 12 mm | 5 ks / 5 pcs | 11893 |

Sestavení držáků pro sluneční kolektory KPG1H, na ležato 15°, na stěnu.

Assembly of triangle brackets for KPG1H solar collectors,
for horizontal installations 15°, on the wall



Po rozbalení
Unpacking

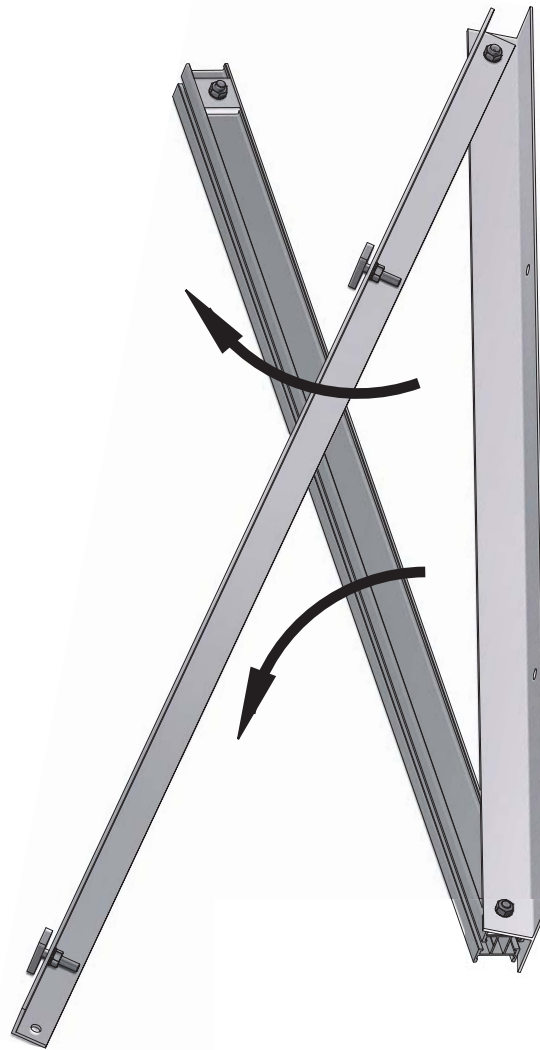

Rozložit
Unfolding

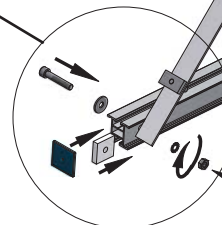
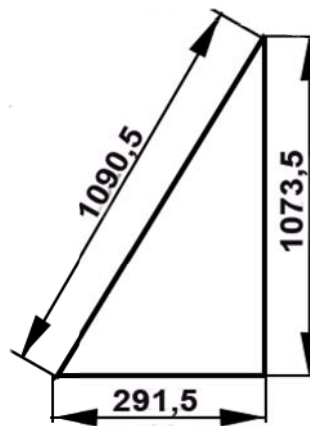
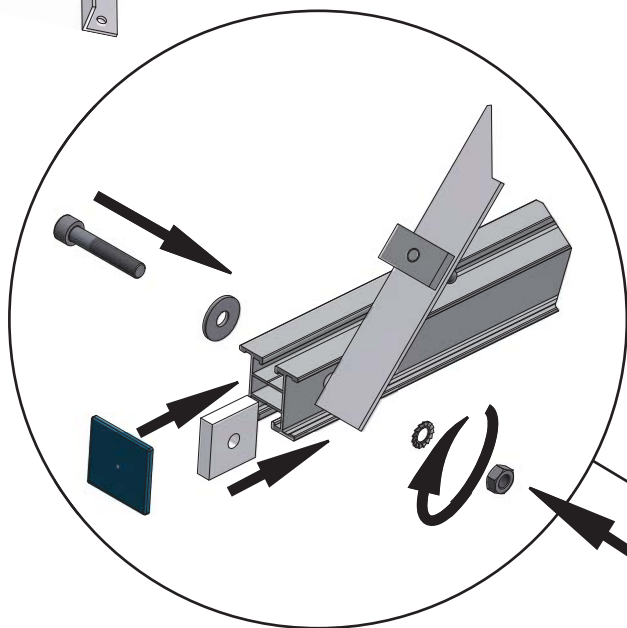

Všechny spoje pečlivě dotáhnout!
Tighten all connections meticulously!

Sešroubovat
Joining together