



www.regulus.eu



CSE2 SOL W SRS1 T-E

Installation and Operation Manual
CSE2 SOL W SRS1 T-E PUMP STATION

EN

CSE2 SOL W SRS1 T-E

1. Introduction

CSE2 SOL W SRS1 T-E twin-line solar pump station contains all components necessary for current and efficient operation. It is designed for operation with one solar consumer (e.g. hot water tank). An auxiliary electric heating element of 2 to 3 kW output can be connected to the heat pump. For its connection, the pump station is equipped with a special socket. The controller controls switching on and off of the heating element. Neither the heating element nor its safety temperature limiter are included in supply.

2. Pump Station Description

Main Features	
Description	<p>The pump station includes:</p> <ul style="list-style-type: none"> – Para ST 25/7-50/iPWM2 circulation pump, – SRS1 T controller, – special socket to connect a heating element of max. 3 kW / 230 V output, – check valve, – safety valve with G 3/4“ F outlet, – ball valves on both flow and return lines, – air eliminator with manual air vent valve, – pressure gauge, – thermometers on both flow and return lines, – two G 3/4“ M valves for filling, draining and topping up the solar thermal system, – G 3/4“ M outlet for connecting an expansion vessel, – 2 already connected temperature sensors of a solar consumer (4 m long), – already connected cable w. silicone insulation to connect a solar sensor (1 m long), – solar temperature sensor (2 m long cable), – already connected 230 V power cord with plug (3 m long, 3 x 1.5 mm² cross section), – mounting kit for installation on a wall or tank, – insulation.
Flow rate measurement	The pump sends the momentary flow rate value as data to controller where it is displayed.
Installation	On a tank or wall using.
Working fluid	Water–glycol mixture (max. 1:1).

Codes corresponding to connection sizes			
Connection	G 3/4“ M	G 1“ M	Cu 22mm
Code	20557	20558	20560

3. Pump Station Data

Data for CSE2 SOL W SRS1 T-E Pump Station	
Max. fluid working temperature	110 °C
Max. working pressure	6 bar
Min. system pressure	1.3 bar with the pump stopped
Flow rate measurement range	2–20 l/min
Ambient temperature	5 - 40 °C
Max. relative humidity	85 % at 25 °C
Power supply	230 V, 50 Hz
Max. switched current	13 A / 230 V
IP rating	IP20
Insulation material	EPP RG 60 g/l
Overall dimensions (w x h x d)	405 x 420 x 155 mm
Total weight	6.5 kg

Min. values of working pressure**

Values of min. working pressure at the pump suction port depending on temperature	0.8 bar at 50 °C
	1.2 bar at 90 °C
	1.8 bar at 110 °C

** this condition is met for current installations when the initial system pressure is set following the formula (see the Instructions for solar collectors): $p = 1,3 + 0,1 \cdot h$ [bar], where h ... is the height from pressure gauge to the middle of collector array [m].

Pump Station Internal Wiring

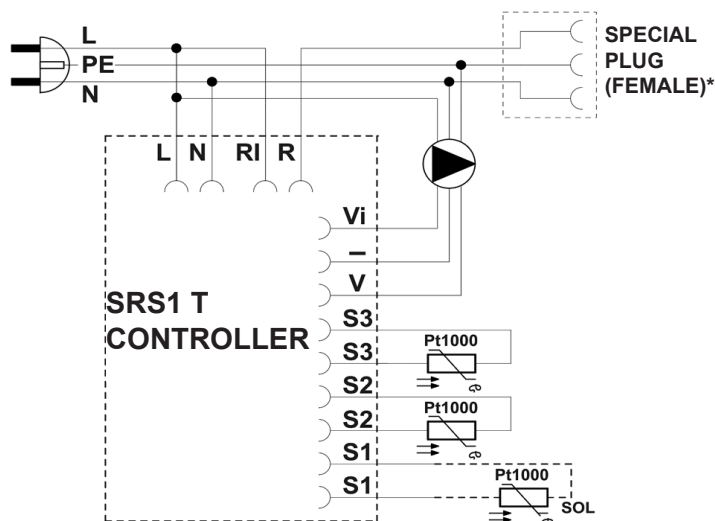

- L *live*
- N *neutral*
- RI, R *potential-free switching contact*
- Vi *iPWM signal input*
- *GND PWM*
- V *PWM signal output*
- S3 *sensor 3 (auxiliary heating)*
- S2 *sensor 2 (solar consumer)*
- S1 *sensor 1 (collector)*

* In pump station to connect a heating element, 3 kW max. output.

Temperature vs. Resistance Table for Pt1000 Sensors

°C	0	10	20	30	40	50	60	70	80	90	100
Ω	1000	1039	1077	1116	1155	1194	1232	1270	1308	1347	1385

3.1 Pressure Drop Graph

Connections G 3/4" M – code **20557**
and Cu 22 mm – code **20560**

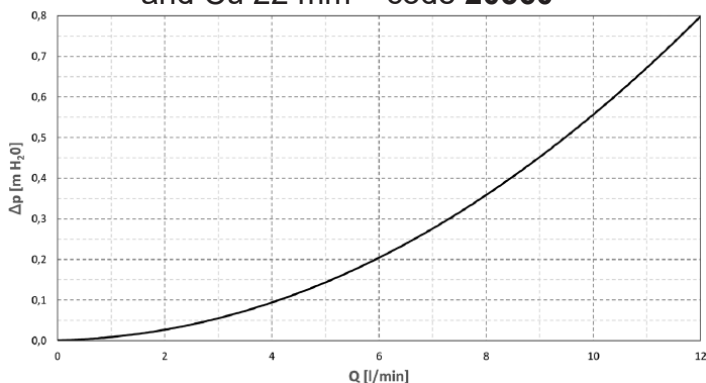

Connections G 1" M – code **20558**

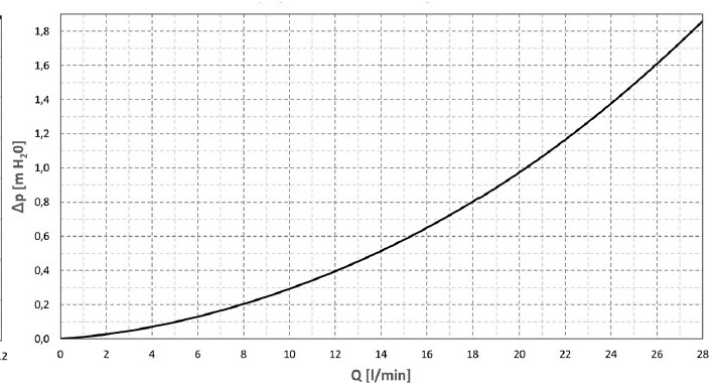

4. Pump Station Components

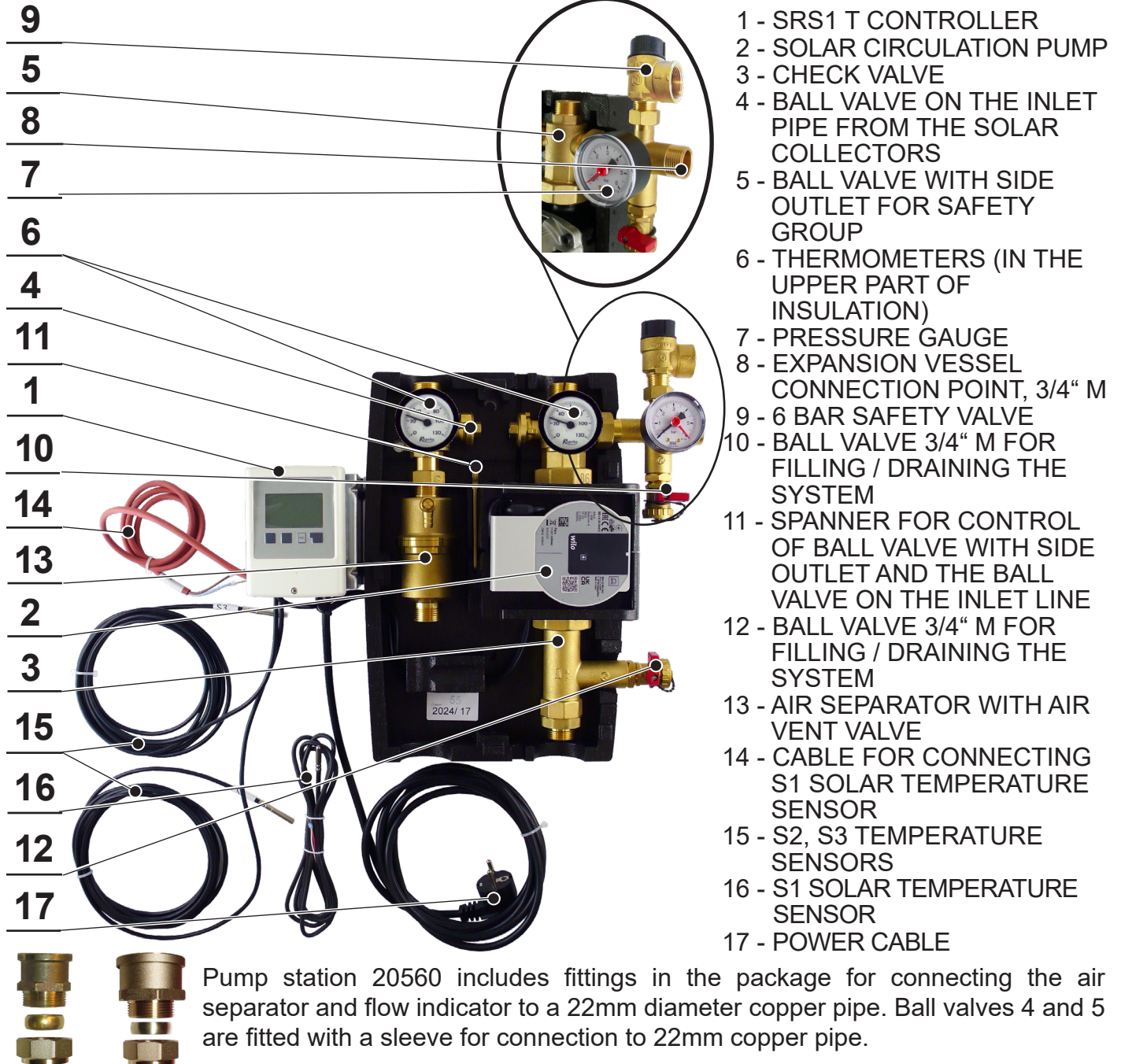

- 1 - SRS1 T CONTROLLER
- 2 - SOLAR CIRCULATION PUMP
- 3 - CHECK VALVE
- 4 - BALL VALVE ON THE INLET PIPE FROM THE SOLAR COLLECTORS
- 5 - BALL VALVE WITH SIDE OUTLET FOR SAFETY GROUP
- 6 - THERMOMETERS (IN THE UPPER PART OF INSULATION)
- 7 - PRESSURE GAUGE
- 8 - EXPANSION VESSEL CONNECTION POINT, 3/4" M
- 9 - 6 BAR SAFETY VALVE
- 10 - BALL VALVE 3/4" M FOR FILLING / DRAINING THE SYSTEM
- 11 - SPANNER FOR CONTROL OF BALL VALVE WITH SIDE OUTLET AND THE BALL VALVE ON THE INLET LINE
- 12 - BALL VALVE 3/4" M FOR FILLING / DRAINING THE SYSTEM
- 13 - AIR SEPARATOR WITH AIR VENT VALVE
- 14 - CABLE FOR CONNECTING S1 SOLAR TEMPERATURE SENSOR
- 15 - S2, S3 TEMPERATURE SENSORS
- 16 - S1 SOLAR TEMPERATURE SENSOR
- 17 - POWER CABLE

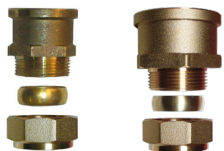

Pump station 20560 includes fittings in the package for connecting the air separator and flow indicator to a 22mm diameter copper pipe. Ball valves 4 and 5 are fitted with a sleeve for connection to 22mm copper pipe.

4.1 Check valve

The check valve prevents the tank from cooling down due to gravity circulation when the sun is not shining. After closing the ball valves it can be removed and cleaned without having to drain the solar fluid from the entire circuit.

4.2 Ball valves

Ball valves are used to separate the pump station from the solar circuit. During servicing (including cleaning of the check valve) there is no need to drain the fluid from the solar system. For greater rigidity of the hydraulic part of the pump station, the upper ball valves are attached to the fixing back plate. The upper ball valves are operated by a lever which is not located on the valve during operation. Turning the lever or the key or pliers a quarter turn to the right closes the ball valve. It opens when the lever is turned to the left. Before closing / opening the ball valve, it is necessary to remove the top part of the insulation. As a result, closing the system is reserved for installation or service technicians only. Thus, the user cannot simply close the solar circuit and cause stagnation and subsequent degradation of the solar fluid. The ball valves are equipped with a spindle packing with two O-rings with dimensions of 8.7x1.8 mm that can be easily replaced by removing the control element with stop ends and loosening the packing nut with a # 21 spanner.

WARNING! IMPORTANT!

The safety relief valve, expansion vessel and upper filling valve always remain connected with the solar thermal system, even when the ball valves are shut off! Never try to isolate them from a filled solar thermal system as there is a risk of serious injury and damage to the system!
Never close the safety valve discharge piping, it shall remain free for fluid eventually discharged by the safety valve!

5. Air Separator with Air Vent Valve

In order to remove air from the circuit perfectly, the pump station is equipped with a so-called air separator with an air vent valve. After filling or topping up the fluid in the circuit and during the pre-season check, it is always recommended to release the air using the air vent valve.



6. Accessories

Code 16942	ETT-N heating element, 2 kW
Code 16943	ETT-N heating element, 3 kW
Code 16940	connector for a special socket located under the controller

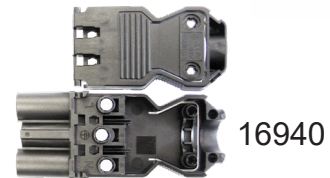

This accessory is not included in supply. When the pump station is used according to diagram number 1 (chapter 8.1), it is necessary to order only the heating element (with connector) - type ETT-N (16942 or 16943). When it is used according to diagrams 3 and 5 (chapter 8.1), it is necessary to order only connector 16940, to which the power supply of circulation pump R1 can be connected.

7. Installation options

The solar pump station is designed to be mounted on a wall or a tank. In the rear section of the insulation there are three mounting holes. The two upper holes are intended for installation on a wall using the mounting kit included in supply. The two lower holes are intended for installation on a tank (160 mm pitch) using the mounting kit included in supply. When mounting the pump station on a tank, use large washers between the tank and pump station for both the holes; the third washer shall be used for the lowest hole between the bolt head (M6x25) and the pump station. The washers are included in supply.

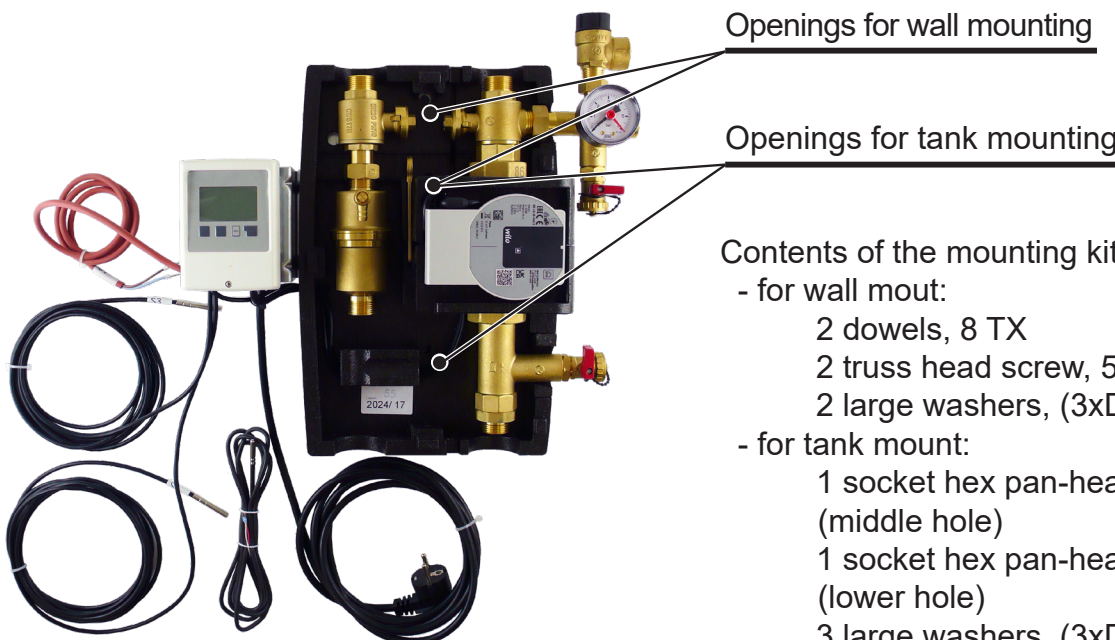

Contents of the mounting kit included in supply:

- for wall mount:

- 2 dowels, 8 TX
- 2 truss head screw, 5x50
- 2 large washers, (3xD) 6.4

- for tank mount:

- 1 socket hex pan-head screw, M6x16 (middle hole)
- 1 socket hex pan-head screw, M6x25 (lower hole)
- 3 large washers, (3xD) 6.4

8. Pump Station Connection Diagram

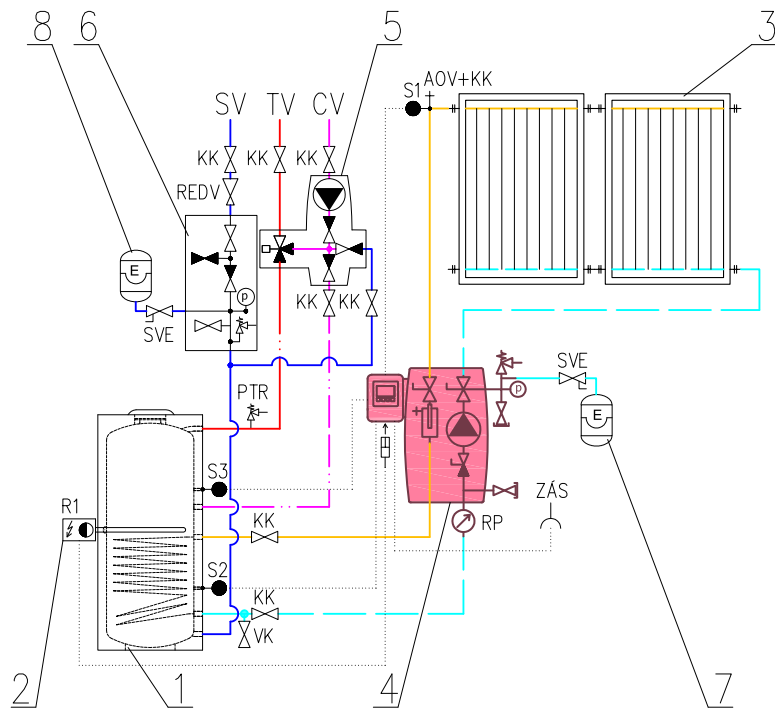

KEY

- 1 – hot water storage tank
- 2 – electric heating element type ETT-N
- 3 – solar collectors
- 4 – **CSE2 SOL SRS1 T-E solar pump station**
– CSE TVMIX ZV
- 5 – pump station for DHW recirculation
– CSE TVMIX ZV
- 6 – safety kit for HW storage tank
- 7 – solar expansion vessel
- 8 – DHW expansion vessel
- SV – cold water
- TV – hot water
- CV – hot water recirculation
- KK – ball valve
- RP – flowrate indicator
- AOV – automatic air vent valve
- PTR – pressure temperature relief valve
- REDV – pressure reducing valve (optional)
- VK – drain valve
- SVE – expansion vessel service valve
- ZAS – 230 VAC, 50 Hz power socket
- S1 – Pt1000 temperature sensor for collector (connected)
- S2 – Pt1000 lower temperature sensor for HW storage tank (connected)
- S3 – Pt1000 upper temperature sensor for HW storage tank (connected)
- R1 – SRS 1 T-E relay R1 (connected - ETT connector)

8.1 Overview of connection diagrams

Explanation: light grey diagram number(2, 4, 6) - setup isn't recommended for this pump station variant.

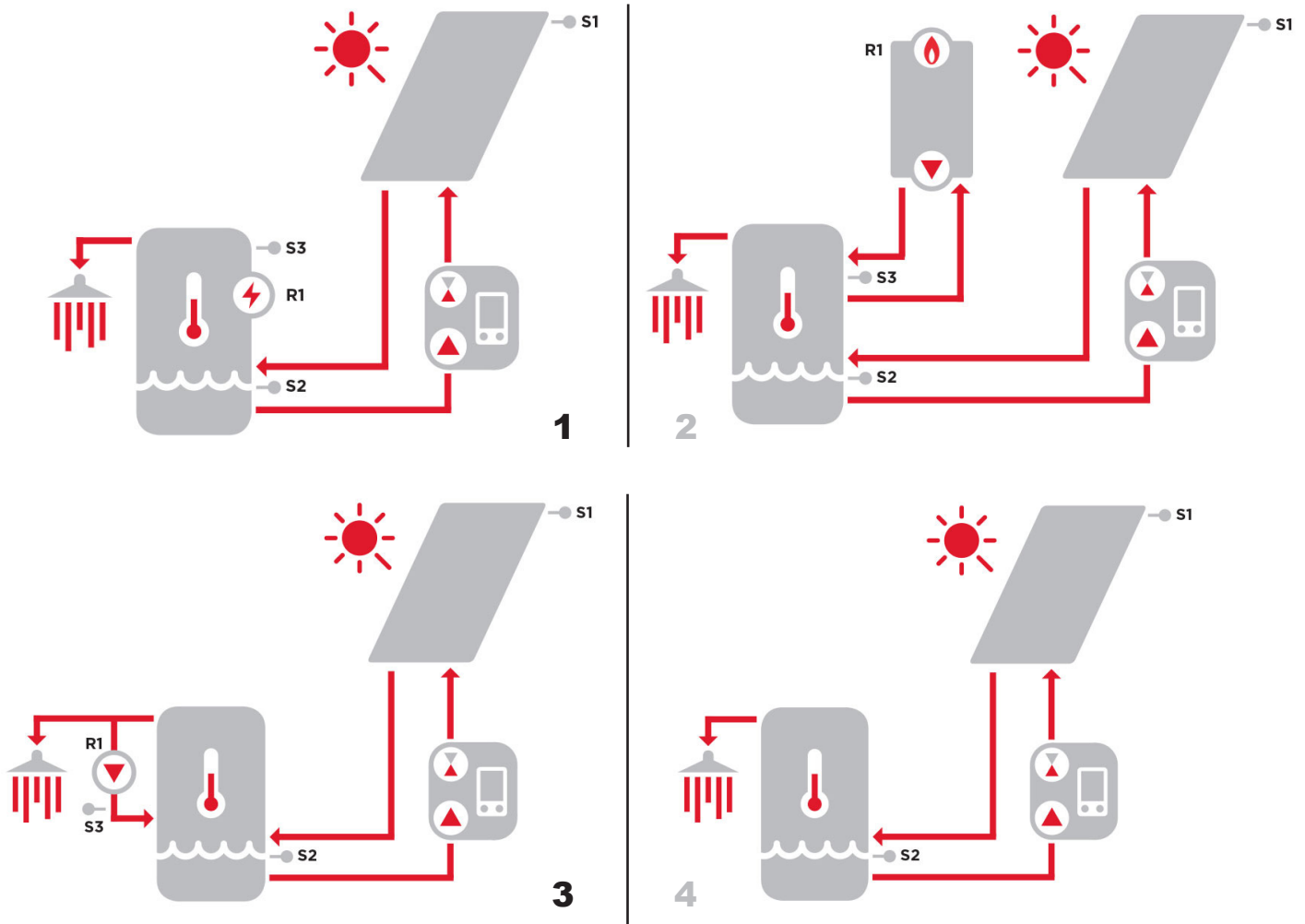

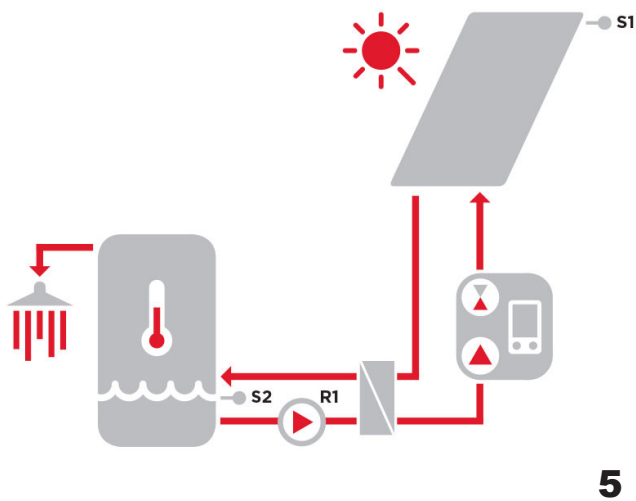

5

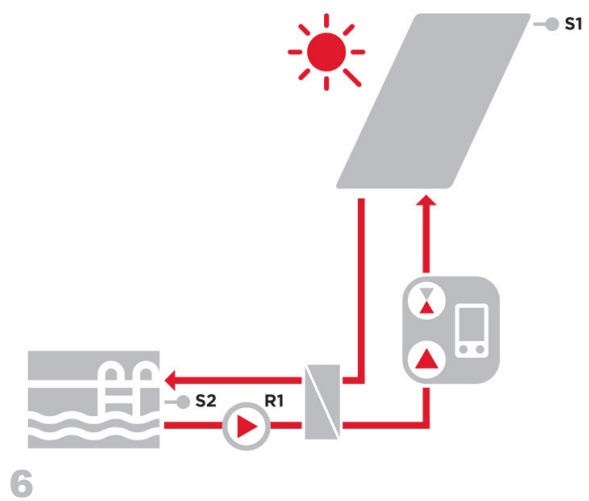

6

9. Wilo-Para iPWM2 Pump



The Wilo Para 25/7 iPWM2 is a wet running circulation pump. The pump speed is controlled by the PWM signal. When the PWM signal is disconnected, the pump stops running (a pump for solar thermal systems). The operating status and possible faults of the pump are indicated by LEDs directly on the pump.

The high efficiency circulation pumps of the PARA iPWM2 series are used exclusively for the circulation of liquids in solar thermal systems. Operating the pump in other systems or in systems containing too little water, air bubbles or not pressurized can lead to its rapid destruction.

9.1 Performance curves

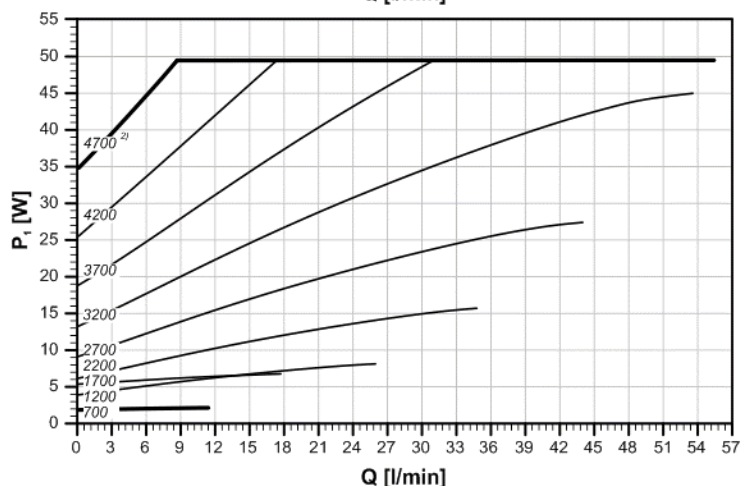
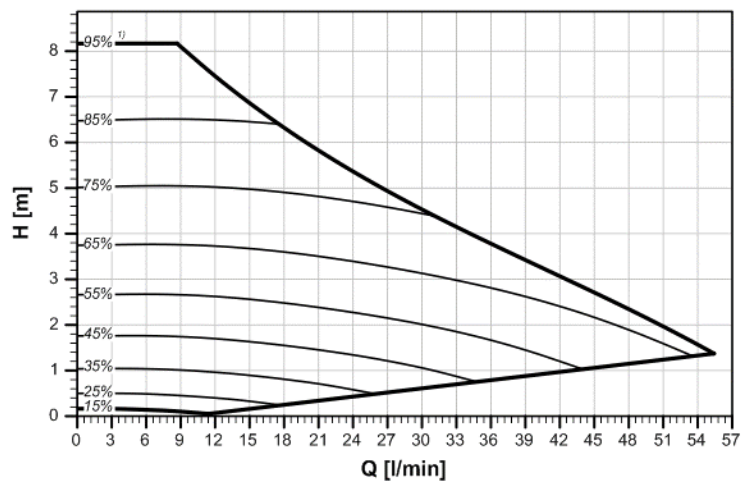

NOTE:





- 1) PWM signal value in %,
- 2) speed in rpm

9.2 Technical Data

Wilo PARA 25/7 iPWM2	
Electric Data	
Power supply	1 ~ 230 V, 50 Hz
Power input (min./max.)	1.8 / 50 W
Current (min./max.)	0.02 / 0.43 A
Max. speed	4700 rpm
Energy Efficiency Index	≤ 0.20 by EN 16 297/3
IP rating	IPX4D
Motor protection	integrated
Operating Parameters	
Fluid working temperature	-10 to 110 °C
Max. static pressure	10 bar

9.3 Graphic signalling of pump operation

 The LED light signals a defect. The pump will switch off (depending on the defect type) and try to restart.

LED Signals	State Description and Possible Fault Reasons
 GREEN IS LIT	1 - pump is running in trouble-free operation
 RED IS LIT	1 - rotor is blocked 2 - electric motor winding defect
 BLINKING RED	1 - power supply lower/higher than 230 V 2 - electric short circuit in pump 3 - pump overheated
 BLINKING RED AND GREEN	1 - unforced fluid circulation through the pump 2 - pump speed lower than desired 3 - air in pump

If the fault cannot be rectified, contact a qualified technician.

10. Filling a Solar Thermal System

For filling a solar thermal system, the ball valve above the pump must be closed and the ball valves below the pump and on inlet pipe from the solar collectors open. The ball valves above the pump are operated by means of the enclosed spanner. Connect the filling pump to the fill and drain ball valves using hoses – see Chap. 4, and open these valves.

Prior to commissioning the system, all 2 of the ball valves must be open!

THIS BALL VALVE MUST BE CLOSED

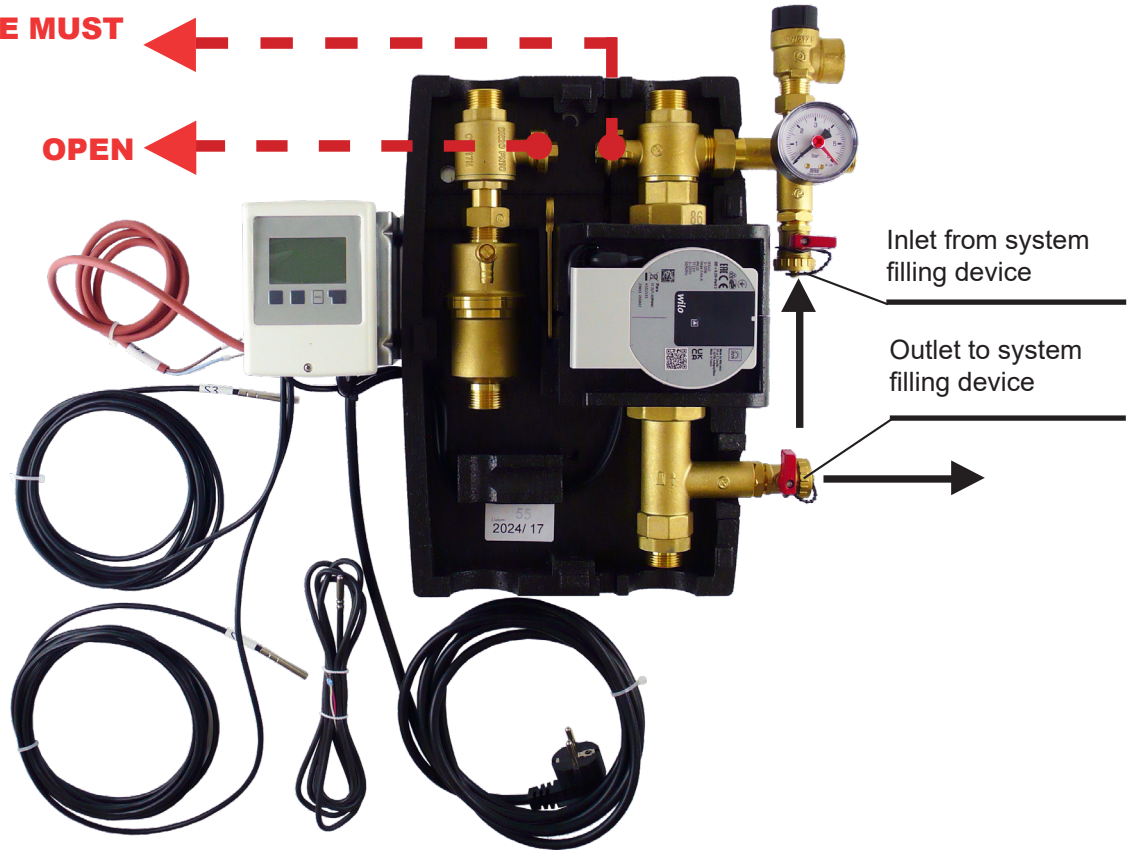

11. Solar System Air Venting

- During operation of the filling pump, close the lower drain valve and increase the pressure to about 5 bar;
- close the upper filling valve and turn off the filling pump, open the ball valve above the pump, do not disconnect the filling pump hoses!
- Set the circulation pump to the highest level in the constant speed mode and, by turning it on and off several times, vent the system using the air vent valve of the air separator and other automatic air vent valves, especially on the solar collectors and others, if they are installed in the system (the de-aerated pump works almost silently);
- continuously monitor the system pressure and if it drops, increase it to 5 bar by turning on the filling pump and opening the filling valve;
- repeat the venting until the float of the flow indicator takes a stable position during pump operation, shows a measurable flow and no bubbles appear in the sight glass. Then let the circulation pump run for at least 5 minutes;
- close the air vent valve of the air separator after air discharge is complete, and if an automatic venting valve(s) is (are) anywhere in the solar circuit, also close this valve after venting.

After filling and air venting the solar thermal system, close the fill/drain ball valve, adjust the system pressure to the required value, disconnect the hoses of the filling pump and re-open the ball valve above the pump.

