



CSE MIX R8 1F

Installation and Operation Manual
CSE MIX R8 1F PUMP STATION
with mixing valve

EN

1. Introduction

CSE MIX R8 1F j pump station is designed to be installed in mixed heating circuits in buildings where it provides circulation and mixing of heating water to a desired temperature, or for solid-fuel boiler circuits where it provides circulation and mixing to a min. heating water temperature as a protection against low-temperature corrosion. Actuator of the mixing valve is controlled by an external controller through 3-point control with 230VAC outputs. The circulation pump is switched by an external controller with a 230 VAC output. The controller is not included in supply.

The pump station is designed to be installed directly on the pipe, with 100 mm min. distance of the pipe axis from a wall.

2. Description of the pump station

The pump station consists of a RPA 25-8 pump including a power cable, a 3-way mixing valve with actuator incl. a power cable, a ball valve and insulation.

Main Features	
Description	consists of a RPA 25-8 pump, a 3-way mixing valve LK 840 with AVC actuator and insulation
Working fluid	Water, water/glycol mixture (max. 1:1). pH range 6.5-8.5. It is recommended to place a filter with a mesh size of max. 0.6 mm – e.g. Magnetfilterball – upstream of the pump station, see the Catalogue for codes.
Installation	flow pipe into a heating circuit / return pipe of a solid fuel boiler, the min. distance of the pipe axis from a wall is 100 mm
Code	21124

Data for CSE MIX R8 1F Pump Station	
Fluid working temperature	5 - 95 °C
Max. working pressure	10 bar
Min. working pressure	0.5 bar
Ambient temperature	5 - 40 °C
Max. rel. humidity	80 % non condensing
Insulation material	EPP RG 60 g/l
Valve Kvs	10 m ³ /h
Leak rate	< 1% Kvs at 5 m H ₂ O pressure difference (at mixing valve inlets)
Max. pressure difference	5 m H ₂ O (at mixing valve inlets)
Overall dimensions	305 x 135 x 195 mm
Total weight	3.9 kg
Connections	3 x G 1" F

3. Pump Station Connection

The pump station may be installed either horizontally or vertically.

Example of possible connection I

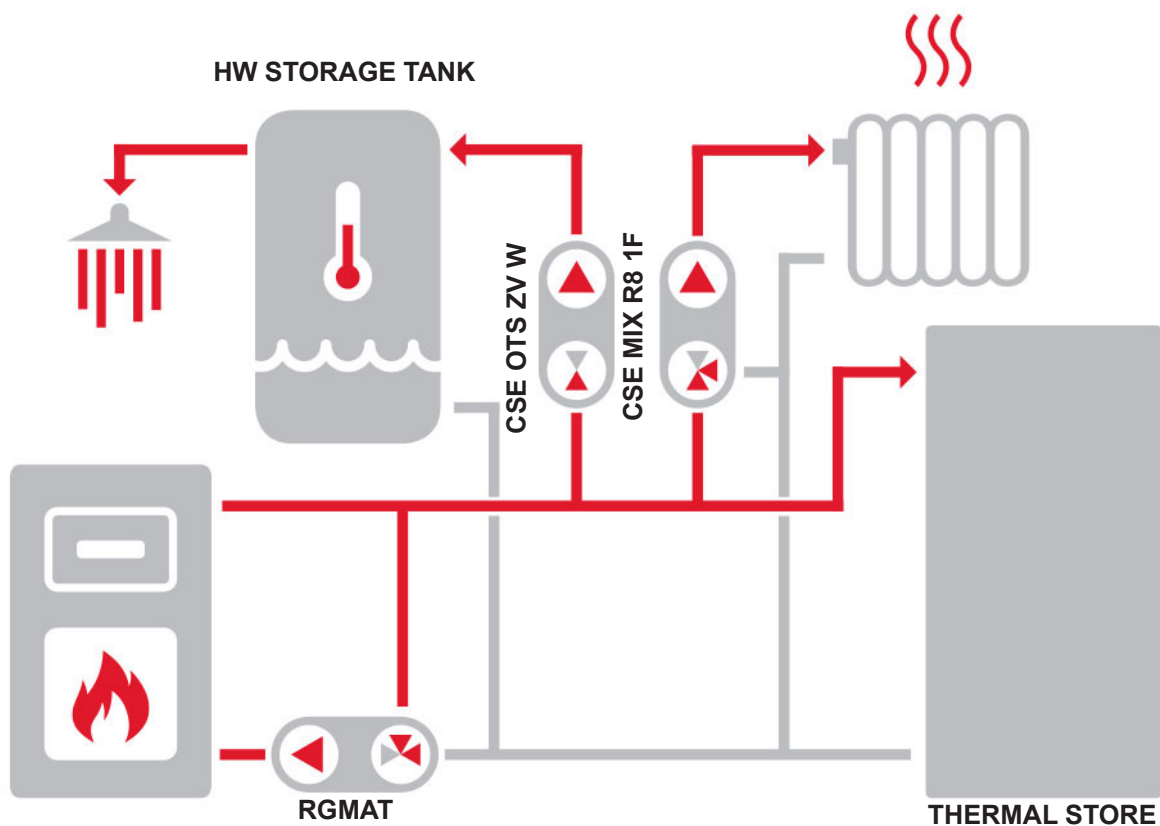

Example of possible connection II

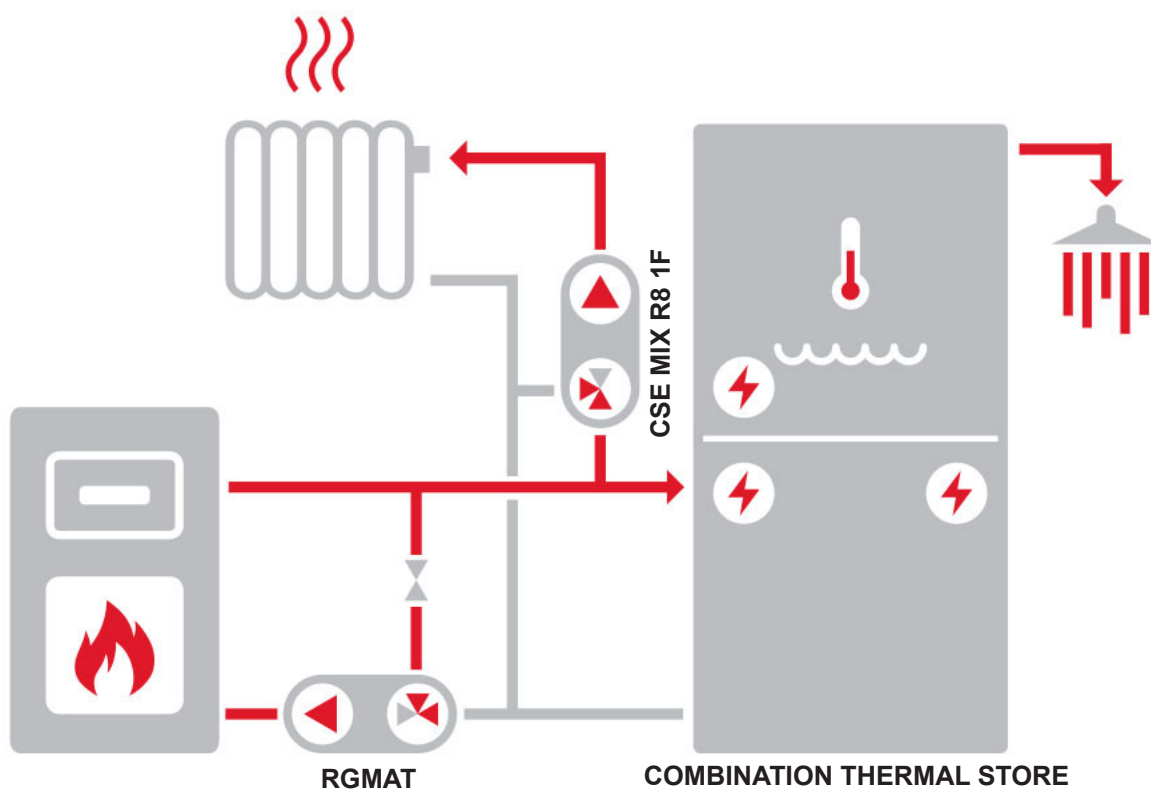

4. Mixing Valve Actuator



Technical data	
Torque	5 Nm
Angle of rotation	90°
Shift time	120 s
Control	3-point (SPDT)
Auxiliary switch	none
Power supply	230 V AC
Max. power input	2.5 VA
IP rating	IP42
Protection class	II by EN 60730-1
Cable (cross section area - length)	3 x 0.5 mm ² - 2 m

actuator wiring

- marking 1, 2, 3 located on the cables

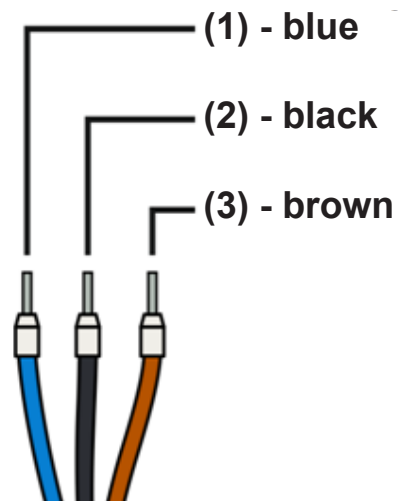
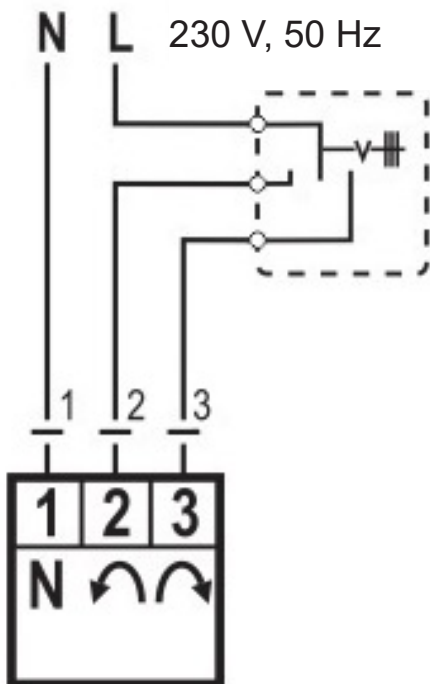

5. RPA 25-8 Pump

5.1. General Information

The high efficiency circulation pumps of the RPA series are used exclusively for the circulation of liquids in hot water heating systems. Operating the pump in other systems or in systems containing too little water, air bubbles or not pressurized can lead to its rapid destruction.

5.2. Pump Description

High efficiency wet-running ON/OFF circulation pump designed for circulation of fluids in heating systems; the pump is equipped with an anti-blocking motor and integrated electronic performance control; LED indication of operation for an easy check; choice between constant speed mode I, II, III, PP mode for variable differential pressure or CP mode for constant differential pressure.

5.3. Permissible and prohibited positions of the pump station



5.4. Pump Wiring

Connecting/disconnecting the pump must be done by a professionally qualified person!

Insert the power cable into the connector on the pump. Connect the wires at the other end of the cable to the corresponding terminals in the terminal block.

5.5. Pump Control

In the factory settings of the RPA 25-8 pump, the Constant Speed (CS) operating mode and the pump performance curve III are preset. After switching on, the pump runs at the factory setting or at the last setting.

The settings can be changed using the control button, see below.

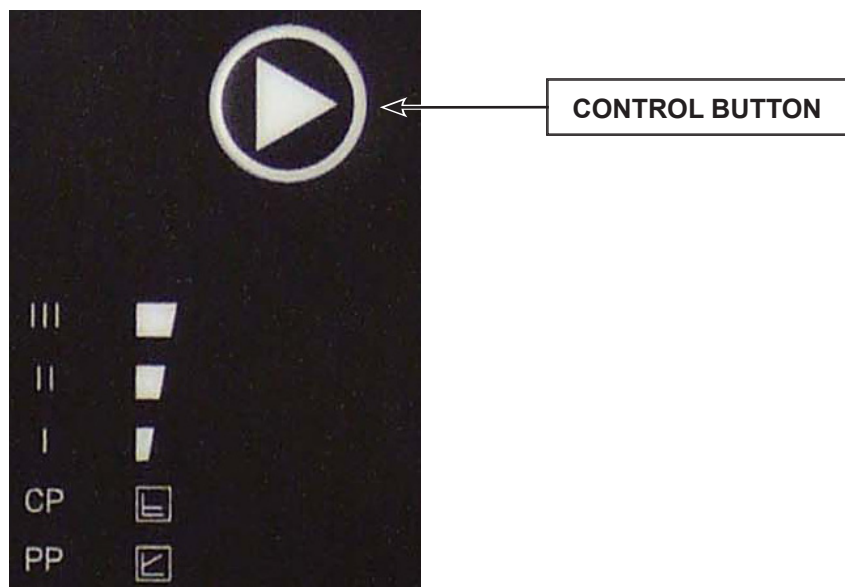

By briefly pressing the control button:

You select the **operating mode** of the pump: constant speed (CS), proportional pressure (PP) or constant pressure (CP) and the pump **performance curve** (I, II, III). The LED lights show the pump settings (operating mode and performance curve).

NUMBER OF PRESSES	OPERATING MODE		LED INDICATORS
0	CS III (factory setting)	constant speed III	
1	PP I	proportional pressure I	
2	PP II	proportional pressure II	
3	PP III	proportional pressure III	
4	CP I	constant pressure I	
5	CP II	constant pressure II	
6	CP III	constant pressure III	
7	CS I	constant speed I	
8	CS II	constant speed II	
9	CS III	constant speed III	

PUMP AIR VENTING

If the pump is aerated:

Activate the vent function by pressing and holding the control button for 5 seconds. Venting is indicated by five flashing LED lights - see picture.

The pump alternately switches on and off during venting. Venting lasts for 5 minutes, after which the pump switches to normal mode.

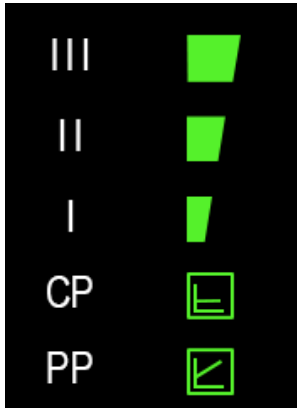

MANUAL RESTART

In case the pump has been stopped for a long time or is blocked, activate the manual restart by holding the control button for 8 seconds. A manual restart is signalled by four flashing LED lights - see the pic., and during it the pump alternately switches on and off.

Manual restart lasts for 5 minutes, after which the pump switches to normal mode.

If the pump is not unblocked, contact a specialist technician.

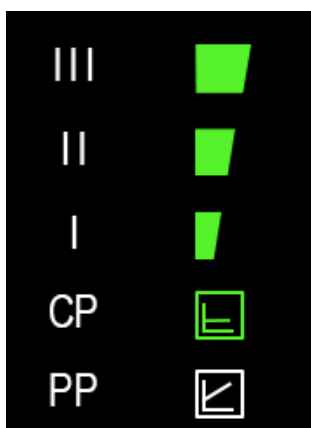

PUMP OPERATING MODES



Proportional pressure PP

The operating mode "proportional pressure" is recommended in systems where it is appropriate to reduce the pump discharge pressure together with the decrease of the required flow rate. A typical example is a heating circuit with radiators equipped with thermostatic valves, when choosing this operating mode can reduce the noise of the thermostatic valves, which is usually caused by closing of a larger number of radiators in the system.

This mode, on the other hand, is unsuitable for circuits of heat sources where a decrease in head together with flow rate can even cause that these sources stop working.

As the pump also reduces the head when reducing the flow rate, there is a substantial reduction in the pump power consumption and thus also the operating costs. For larger heating circuits and for circuits where there are significant differences in the heating performance requirements in separate heating zones, this mode can temporarily cause underheating. For these systems, it may be more appropriate to switch the pump to constant pressure mode CP.

Performance curves

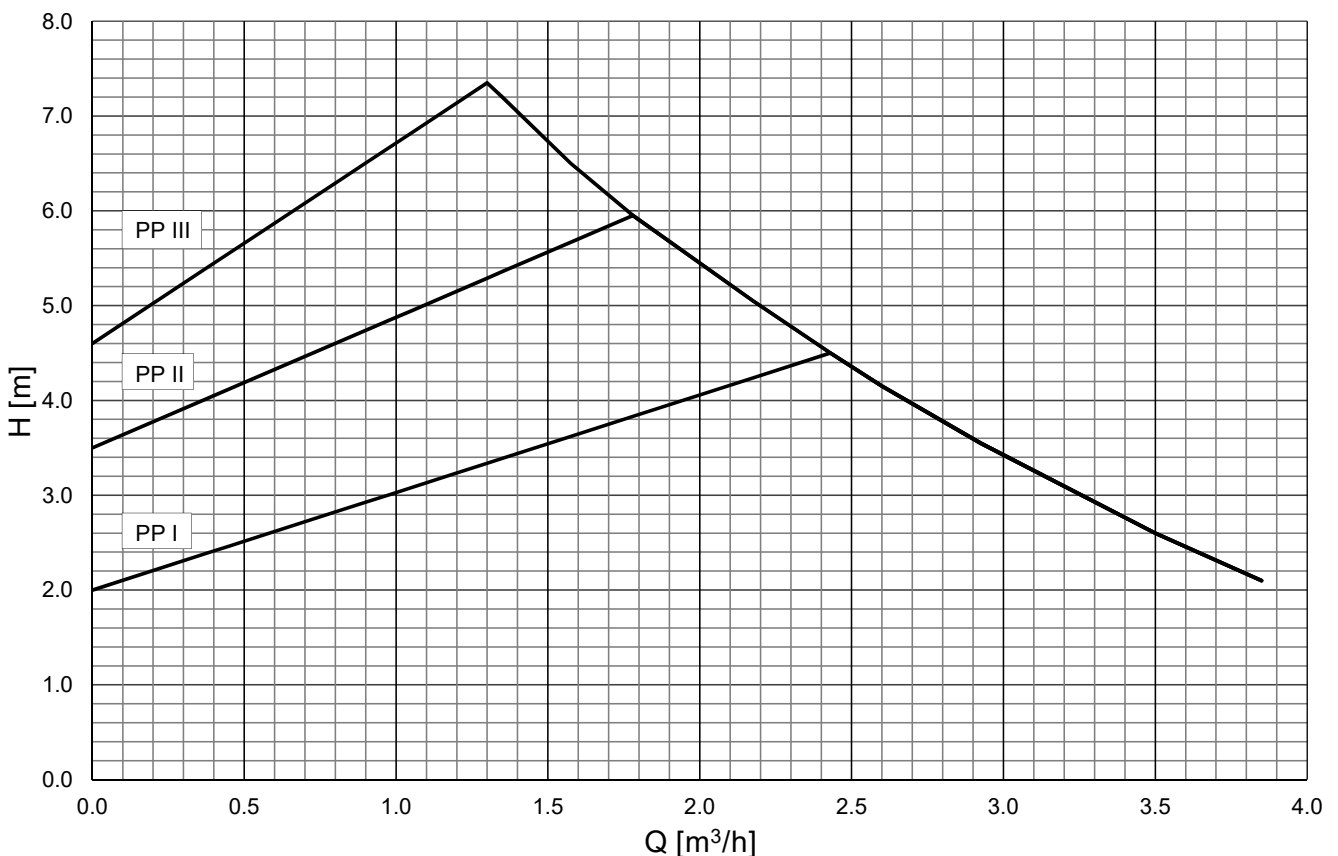



Constant pressure CP

The operating mode "constant pressure" (constant head) is suitable for hydraulic circuits of heat sources (boilers, heat pumps, solar thermal systems, etc.), hot water tanks, hot water heaters, floor heating systems and extensive heating circuits where the previous PP mode could cause underheating by reducing the head.

By reducing the required flow, the pump maintains a constant head, so the reduction of pump performance is more gradual than in the PP mode.

Performance curves

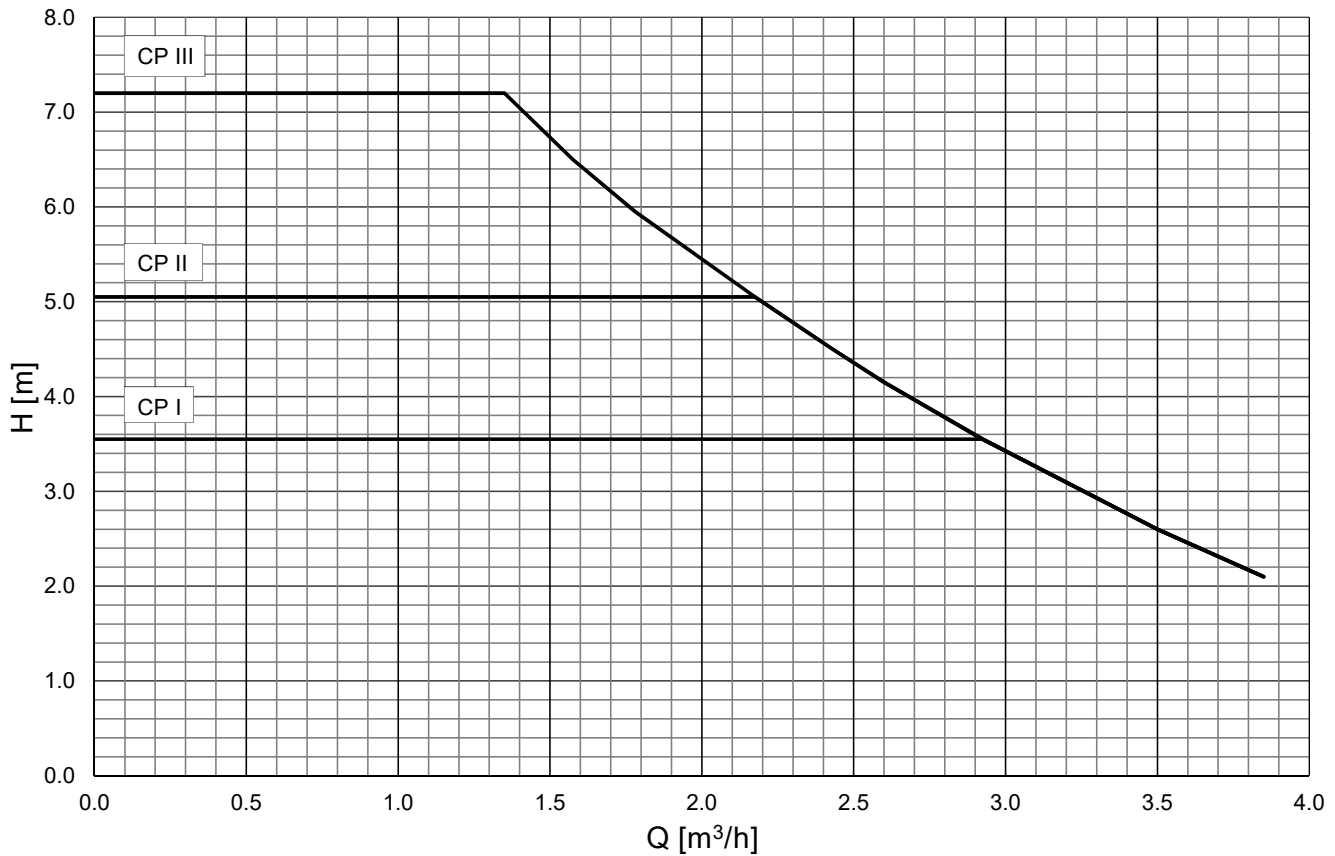



Constant speed CS

The operating mode "constant speed" means that the pump does not adjust its speed in any way depending on the flow rate or head of the hydraulic circuit. The flow rate and head of the pump is therefore completely dependent on the set speed level (I, II, III) and on the setting of the hydraulic circuit. This mode is used where the more economical CP mode is not suitable. This is the same mode that older types of classic circulation pumps had, where the speed mode I, II, III was selected with a switch.

The mode may be suitable e.g. for older types of circuits where the flow rate is regulated by a throttle and the requirement is to maintain it. Furthermore, it can be suitable for solid fuel boilers that are equipped with older types of TSV valves with balancing by means of a manual throttle valve, or in other similar specific cases of a requirement for a constant pumping performance of the pump.

Performance curves

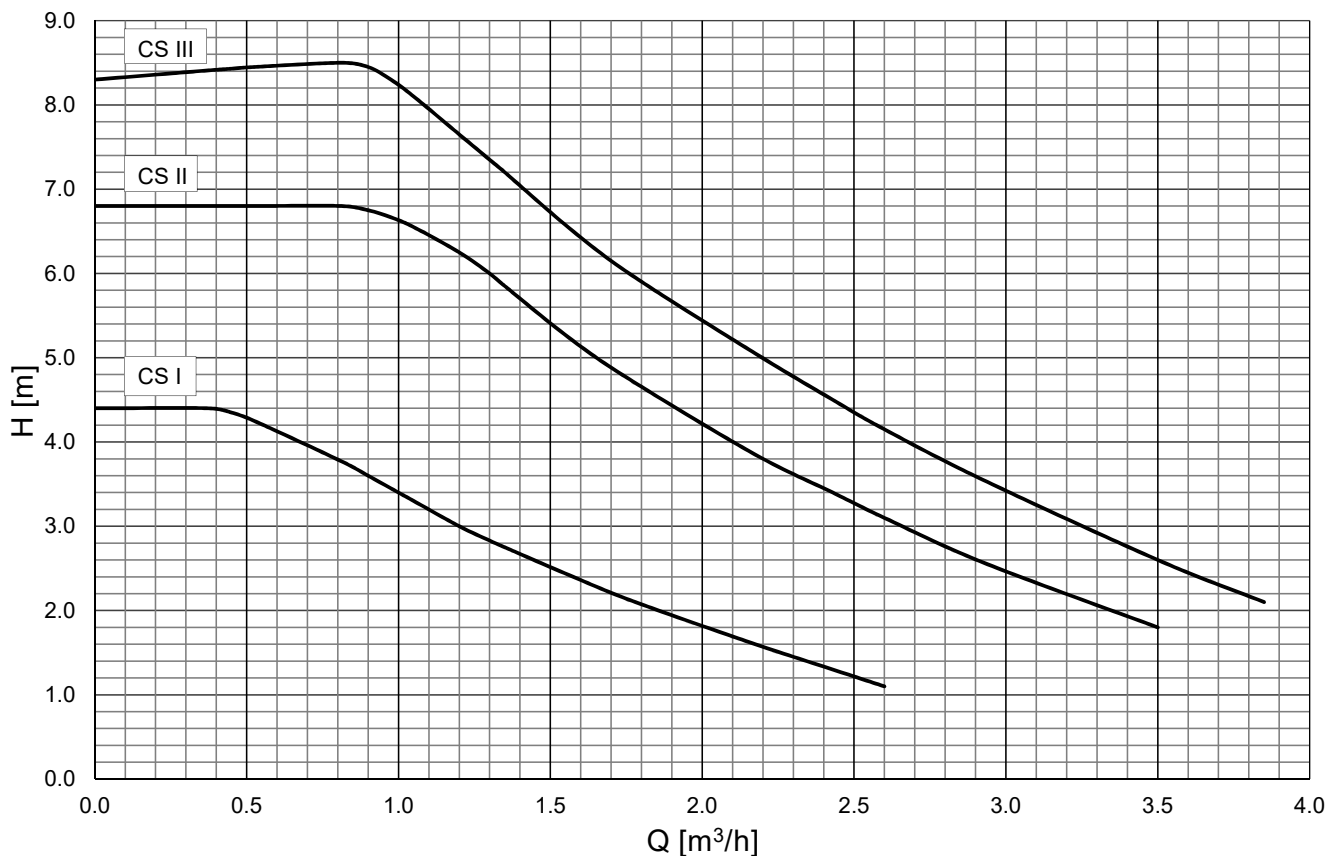

5.6. Technical Data

Electric Data	
Power supply	1~230 V, 50/60 Hz
Max. power consumption	65 W
Max. current	0.65 A
IP rating	IP 44
Insulation class	F
Motor protection	not needed (block resistant)

5.7. FAULTS, THEIR CAUSE AND TROUBLESHOOTING

FAULT	PROBABLE CAUSE	TROUBLESHOOTING
Pump not running	Loose cable or power interruption	Check the power supply and power cable connection
	Damaged pump control electronics	Replace the pump
	Blocked pump impeller	Disconnect the actuator and clean the pump
Noise in heating system / pump	Low pump suction pressure	Increase the pump suction pressure above the min. working pressure value - see chap. 2
	Air in the system or pump	Vent the system and the pump
Pump is running but no fluid circulation through system	Closed valve in system	Check that valves are open
	Air in the system	Vent the system

Some types of faults are signaled on the pump with LED lights:

FAULT	SIGNAL	PROBABLE CAUSE	TROUBLESHOOTING
Blocked pump impeller		Impurities in the pump	Remove the actuator and clean the pump
Overtoltage or undervoltage		The mains voltage is too high or too low	Check that the power cable is correctly attached and that the mains voltage is correct
Power phase interruption inside the pump		Broken motor winding or other interruption of the power phase inside the pump	Replace the pump
Electrical short circuit inside the pump		Damaged motor winding or other electrical short inside the pump	Replace the pump

If the fault cannot be rectified, contact a specialist technician.

6. Installation options

The pump station comes with a mixing valve in the left-hand position (see Fig. 1). If this installation position is convenient, there is no need to make any adjustments. When needed, the mixing valve can be rotated to the right-hand position (see Fig. 2). After the valve is turned by 180° and the fittings tightened, the actuator lock shall be unscrewed and screwed into the opening at the other valve side (see Fig. 2), and the position of the valve member and of the actuator changed (see the paragraph and pictures below).

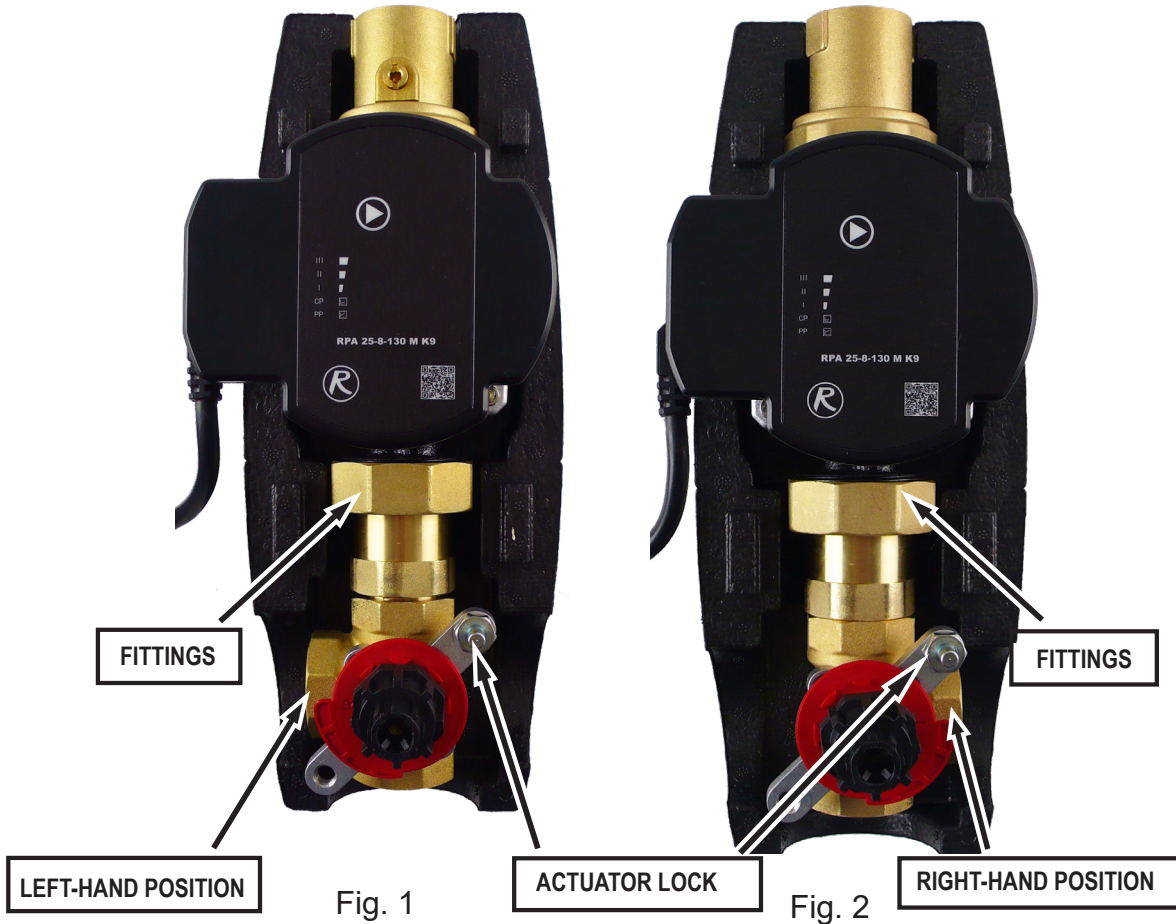

Actuator adjustment

Having turned the valve to the right hand position, turn the D-shaft in such a manner that the valve member is between inlets 1 and 3, turn the red plastic wheel properly (see Fig. 4) and finally fit the plastic adapter (the arrow on the plastic adapter forms an angle of 45° with inlets 1 and 3, see Fig. 4). **The flat spot on the shaft and the arrow on the plastic adapter shall be on the same side as the valve member!**

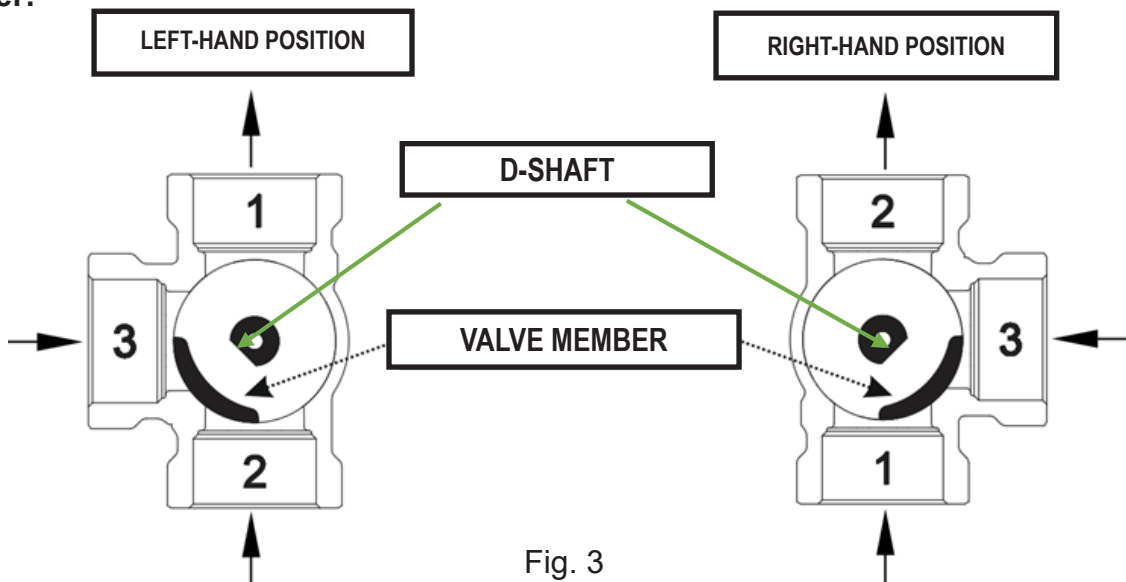

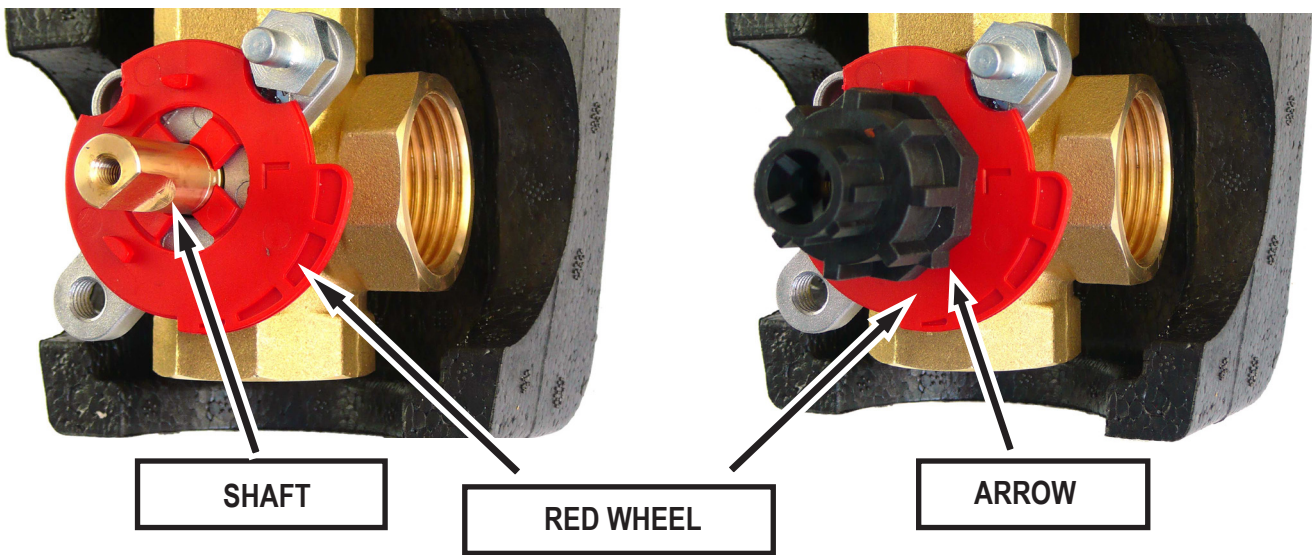
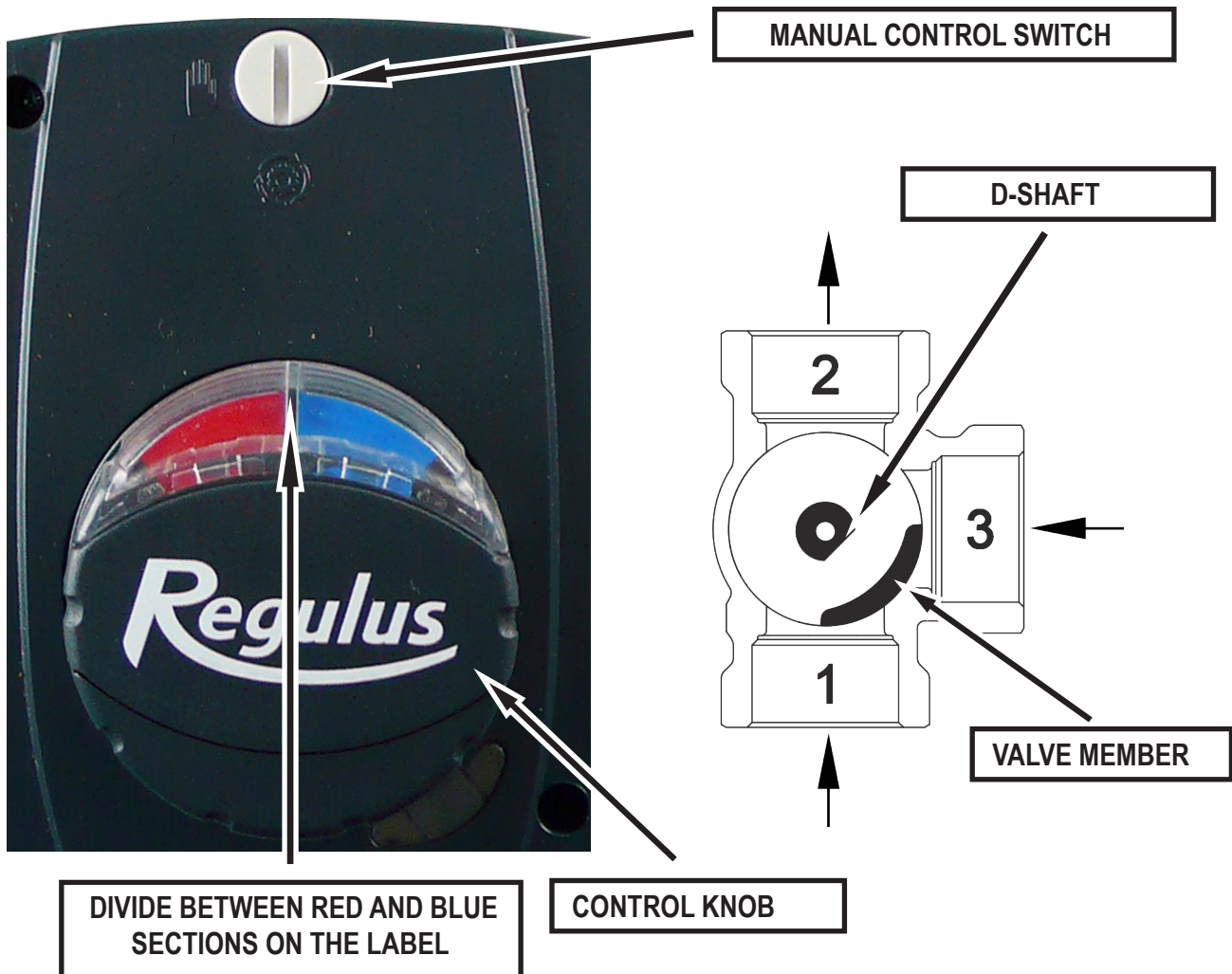

Fig. 4

Prior to fitting the actuator on the plastic adapter, switch it to manual control, set the control knob to the middle of its control range (i.e. to the divide between red and blue on the label) and then fit the actuator onto the adapter already on the valve. The control knob shall be able to turn freely both to left and right by 45°. When turned to the right by 45°, the path 1 is closed, and when turned to the left by 45° the path 3 is closed. Having performed the check, turn the knob back to automatic control.



After the actuator is fitted, the correct position of the round indication label (hot/cold) shall be checked as to the right function and position of the valve; the colours shall correspond to the cold and hot water connections. In case of a vertical installation in central heating, the red mark on the label shall be on the right-hand side for left-hand installations (see Fig. 5) and on the left-hand side for right-hand installations (see Fig. 6).



Fig. 5



Fig. 6

In case of a horizontal installation with a solid fuel boiler, the red mark on the label shall be on the right-hand side for right-hand installations (boiler to the left from the pump station, see Fig. 7) and on the left-hand side for left-hand installations (boiler to the right from the pump station, see Fig. 8).

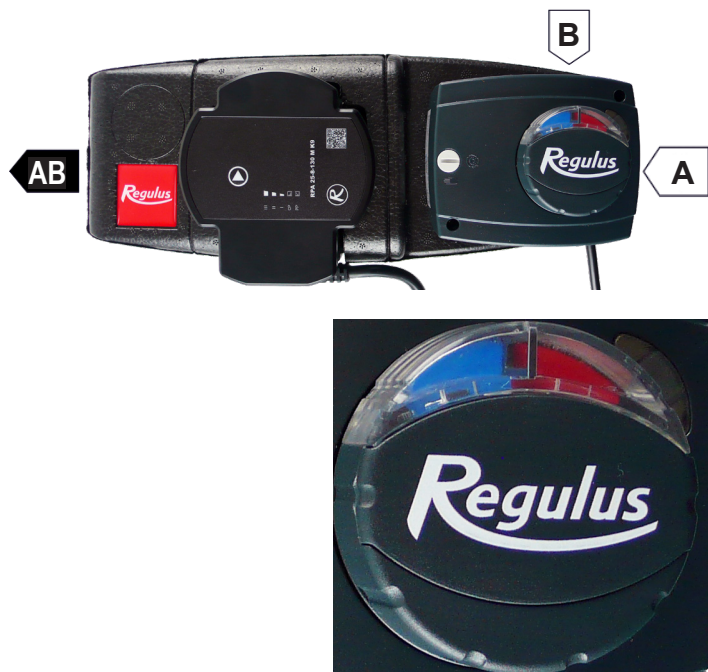

Fig. 7

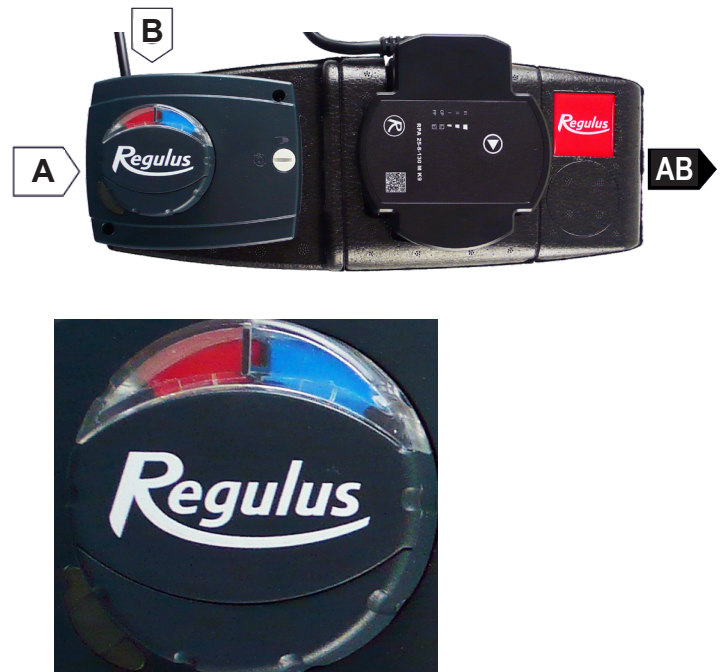

Fig. 8

