

Regulus

www.regulus.eu

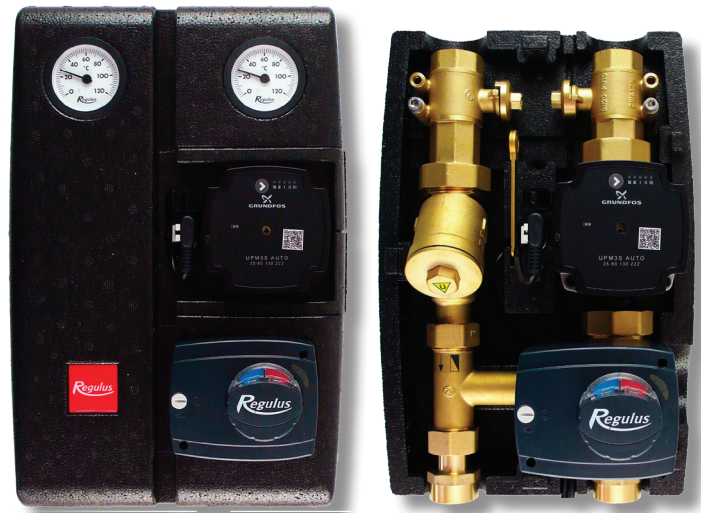

CSE2 MIX F G60 1F

Installation and Operation Manual
CSE2 MIX F G60 1F PUMP STATION

EN

CSE2 MIX F G60 1F

Contents

1.	INTRODUCTION	3
2.	PUMP STATION DESCRIPTION AND DATA	3
3.	PUMP STATION COMPONENTS	4
3.1.	GRUNDFOS UPM3 AUTO 25-60 PUMP	5
3.2.	MIXING VALVE WITH ACTUATOR	8
3.3.	CHECK VALVE	8
3.4.	FILTER WITH MAGNET	8
3.5.	BALL VALVES	8
4.	EXAMPLES OF PUMP STATION CONNECTION	10
5.	PUMP STATION INSTALLATION	12
6.	TEMPERATURE SENSOR INSTALLATION	13
7.	OPTIONAL ACCESSORIES	15
	APPENDIX – ACTUATOR ADJUSTMENT	19

1. INTRODUCTION

CSE2 MIX F G60 1F twin-line pump station is designed for mixed heating circuits. It provides flow through the heating system, mixes to the outlet temperature using a motorized mixing valve (controlled by an external controller). The pump station includes a filter with magnet, so it is also suitable for older steel pipe systems. It can be easily mounted on a wall or on a manifold for multiple heating circuits.

2. PUMP STATION DESCRIPTION AND DATA

Main Features	
Description	The twin-line pump station consists of: <ul style="list-style-type: none"> • Grundfos UPM3 AUTO pump • 2 ball valves w. sensor sheath • check valve • filter with strainer&magnet • LK 840 mixing valve w. actuator • thermometers, insulation
Working fluid	water, antifreeze heat-transfer fluid for heating systems
Installation	vertically on a wall or manifold (125 mm pitch)
Connections	4 x G 1" F
Code	19103

Data for CSE2 MIX F G60 1F Pump Station	
Fluid working temperature	5 - 95 °C
Max. working pressure	10 bar
Min. working pressure	0.5 bar
Ambient temperature	5 - 40 °C
Max. relative humidity	80%, non condensing
Pump power supply	1 ~ 230 V, 50 - 60 Hz
Pump station max. power input	42 W
Mixing valve Kvs	6.3 m³/h
Max. pressure difference	5 m H ₂ O (at mixing valve inlets)
Leak rate	< 1% Kvs at 5 mH ₂ O pressure difference (at mixing valve inlets)
Mixing valve power supply	230 V, 50 Hz; from external controller w. 3-point control
Valve shift time	120 s
Insulation material	EPP RG 60 g/l
Overall dimensions	360 x 181 x 245 mm
Total weight	6.7 kg
Connections	4 x G 1" F

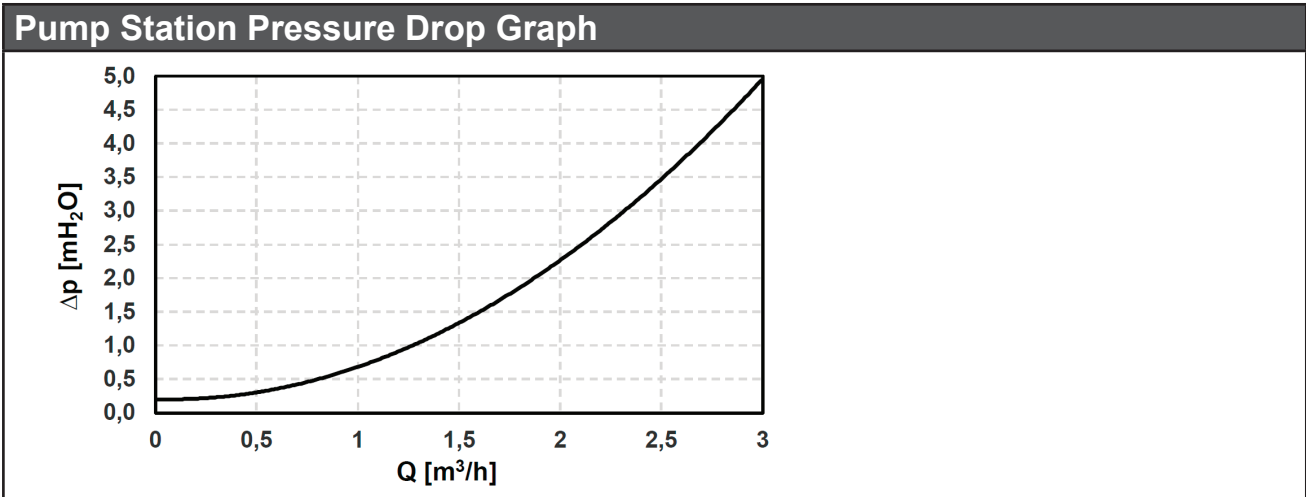

3. PUMP STATION COMPONENTS

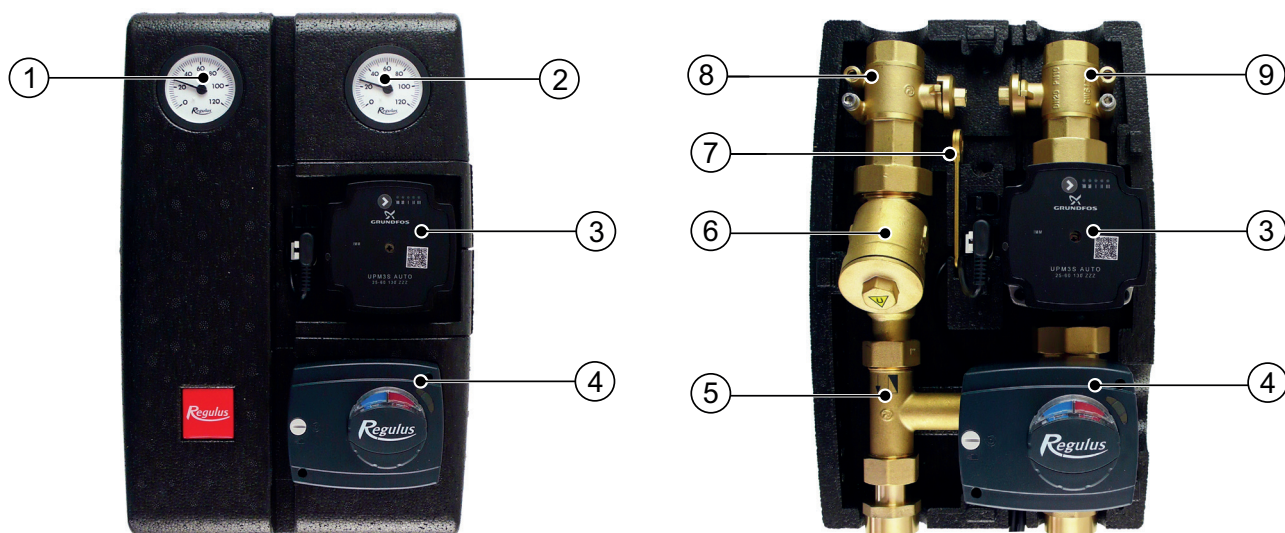

- 1 – Thermometer at the heating circuit return
- 2 – Thermometer at the heating circuit flow
- 3 – Grundfos UPM3 AUTO 25-60 circulation pump
- 4 – Mixing valve w. actuator
- 5 – T-piece with check valve
- 6 – Filter w. magnet
- 7 – Lever for ball valves
- 8 – Ball valve w. sheath for temperature sensor (heating circuit return)
- 9 – Ball valve w. sheath for temperature sensor (heating circuit flow)

3.1. GRUNDFOS UPM3 AUTO 25-60 130 MM PUMP

Wet-running circulation pump with G 6/4" M connection.

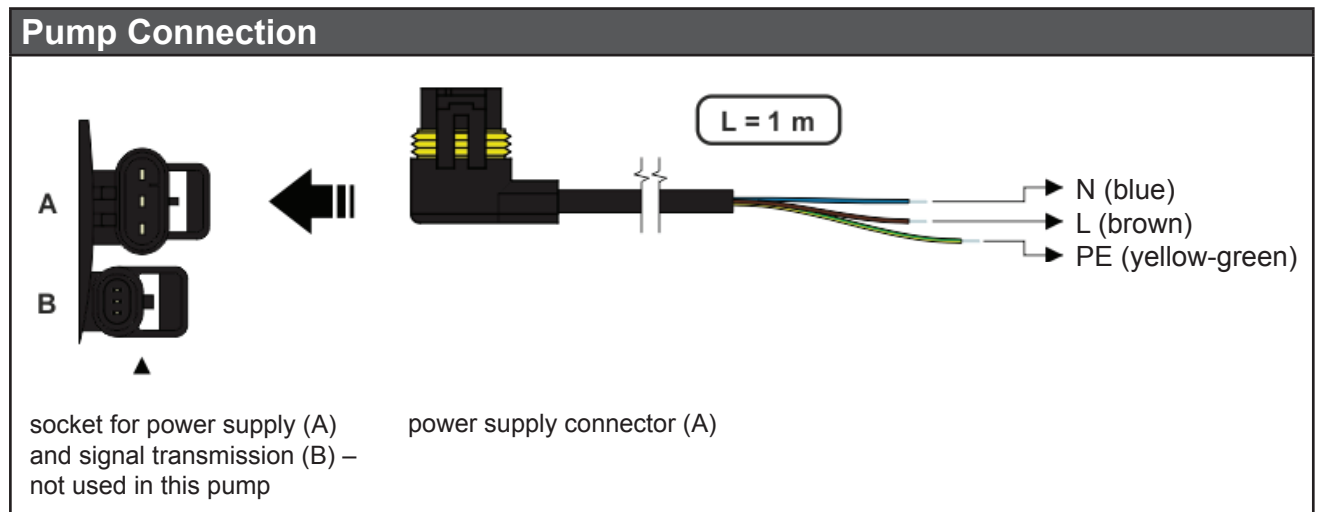

Pump control

The circulation pump can be controlled by selecting a suitable profile and performance curve.

Performance curves

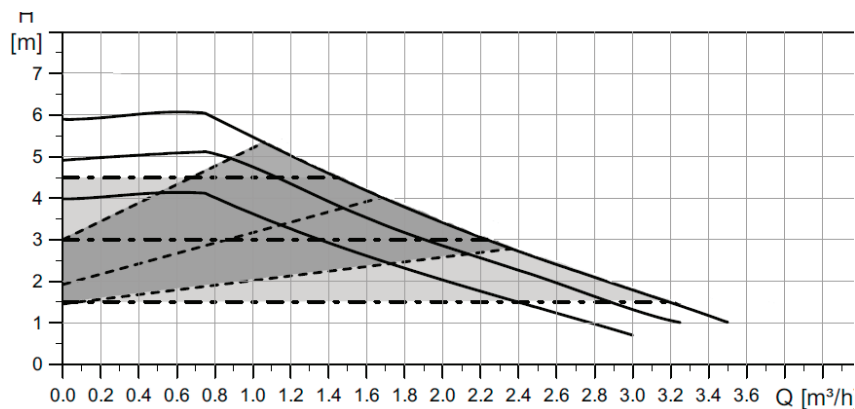



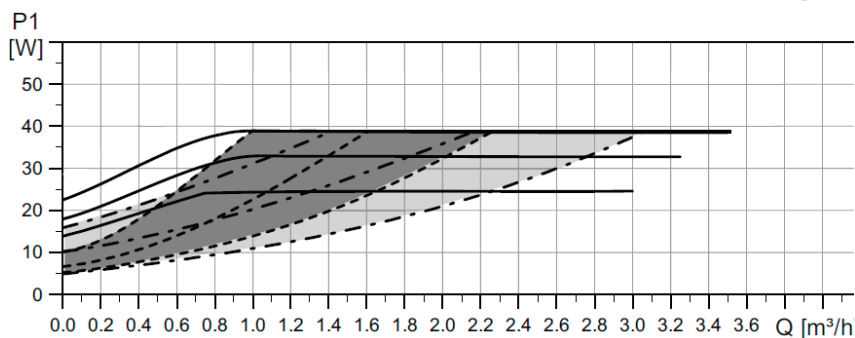

Line type	Profile
	Constant speed
	Proportional pressure
	Constant pressure



Description of Pump Profiles





a) Proportional pressure

- This mode is suitable for heating systems with radiators, to reduce noise caused by heating fluid flowing through thermostatic valves.
- Head (pressure) decreases with decreasing flow rate (increasing system pressure drop).
- Pump operating point: lies on the selected proportional pressure curve depending on the current system pressure drop.

CONTROL MODE		DESCRIPTION	
Proportional pressure	I	The lowest curve of proportional pressure	
	II	The middle curve of proportional pressure	
	III	The highest curve of proportional pressure	
	AUTO _{ADAPT}	Automatically controls performance in the range from the highest to the lowest proportional pressure curve	



b) Constant pressure

- This mode is suitable for underfloor heating or for piping of a bigger size. It is also suitable for all applications without variable characteristics (e.g. pumps for heating up a HW storage tank) or for a circuit with a heat exchanger.
- Head (pressure) remains the same in the whole range of flow rates (does not change with the system pressure drop).
- Pump operating point: moves on the selected constant pressure curve depending on the current system pressure drop.

CONTROL MODE		DESCRIPTION	
Constant pressure	I	The lowest curve of constant pressure	
	II	The middle curve of constant pressure	
	III	The highest curve of constant pressure	
	AUTO _{ADAPT}	Automatically controls performance in the range from the highest to the lowest constant pressure curve	

c) Constant speed

- This mode is suitable for the maximum utilization of the pump performance or for use in systems with constant resistance which require a constant pumping performance.
- Head (pressure) increases with decreasing flow rate (increasing system pressure drop).
- Pump operating point: moves up or down on the selected curve depending on the current system pressure drop.

CONTROL MODE		Max. H (upper graph)	Max. P ₁ (lower graph)	
Constant speed	I	4 m	25 W	
	II	5 m	33 W	
	III	6 m	39 W	

Settings Display

	DISPLAY	CONTROL MODE	
	green LED FLASHING	INTERNAL	
1		Proportional pressure AUTO _{ADAPT}	
2		Constant pressure AUTO _{ADAPT}	
3		Proportional pressure	I
4			II
5			III
6		Constant pressure	I
7			II
8			III
9		Constant speed	I
10			II
11			III

WARNING: LEDs may be turned by 90° or 180°, or mirrored, depending on the specific pump type.

During operation, the selected pump profile is indicated by green LEDs and the power level by yellow LEDs.

Setting selection

Pump profiles can be switched by pressing the integrated button. The pump profiles change in a closed loop in the order shown in the table.



Error Display

DISPLAY	ERROR
	Seized pump
	Too low power supply voltage
	Electric fault

3.2. MIXING VALVE WITH ACTUATOR

The LK 840 mixing valve is equipped with a 3-point control actuator. The current valve member position is obvious from the position of the line in the sightglass of the control knob. The slide switch on the actuator housing can be used to switch between motorized and manual control. When the manual control is set, the actuator is controlled by turning the knob.

ACTUATOR ELECTRICAL WIRING

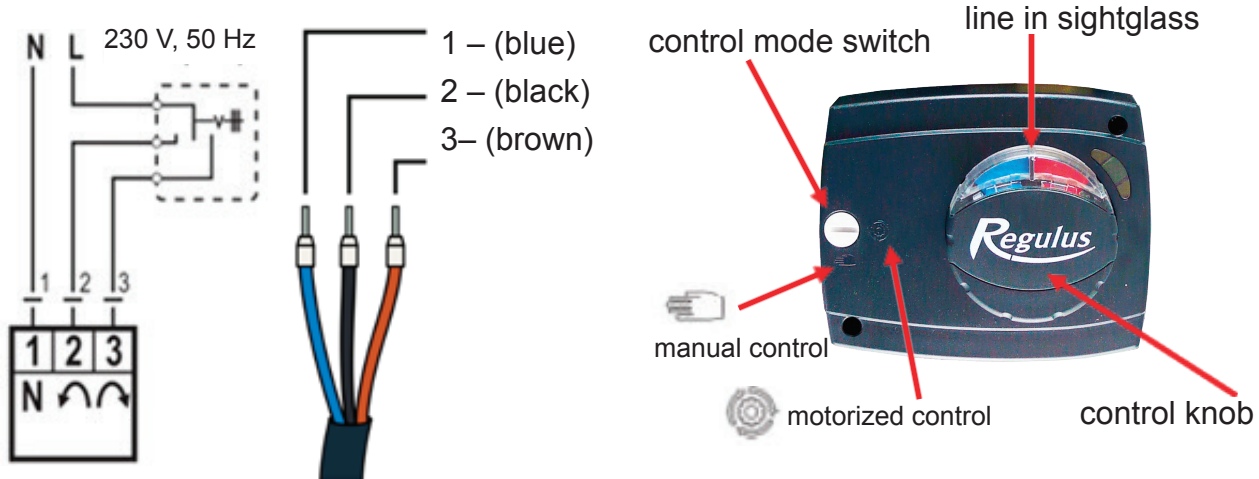

The actuator is factory set to motorized control and ready for operation. Should it be inevitable to remove it or replace, please follow the instructions in the appendix.

3.3. CHECK VALVE

A check valve located downstream of the filter prevents natural circulation in the heating circuit.

3.4. FILTER WITH MAGNET

The filter located in the return line of the pump station is designed to collect particles from heating water. It consists of a brass housing, removable stainless-steel strainer collecting coarse dirt, and a brass lid with a magnet that attracts magnetic particles.

The filter needs to be checked regularly, and cleaned when needed. Turn off the circulation pump, close the ball valve upstream of the filter. Water inlet downstream of the magnet is closed by the check valve. Unscrew the filter lid, remove the stainless steel strainer and flush thoroughly. Wipe the impurities on the magnet and re-assemble the filter by inserting the strainer, screwing in and tightening the lid.

3.5. BALL VALVES

Ball valves are intended to isolate the pump station from the heating circuit. Then it is not necessary to drain the heating circuit for servicing (incl. cleaning the filter). In order to have a more solid hydraulic section of the pump station, they are fixed to the rear mounting plate.

The ball valves are controlled by a lever that is placed inside the pump station insulation. The valve is closed or opened by turning the lever by 90°. The state of the valve is indicated by the groove on the control hexagon of the valve. The ball valve can be accessed only after the front section of the insulation is removed. As a result, unintentional closure of the system by an unauthorized person is not possible.

OPEN

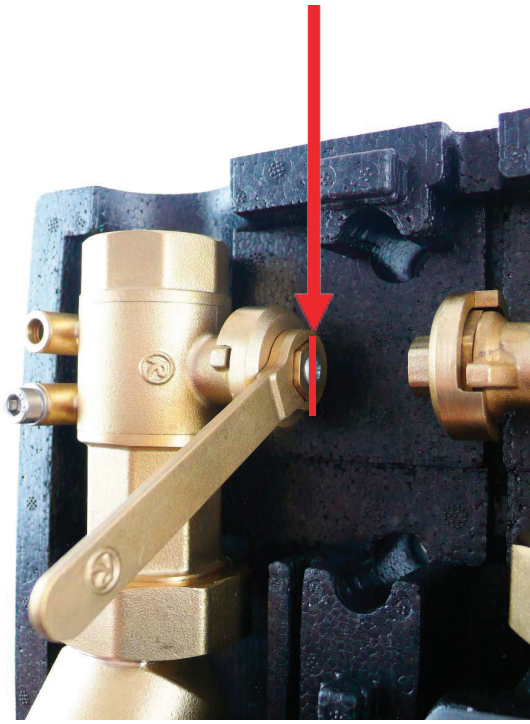

groove in the flow direction

CLOSED

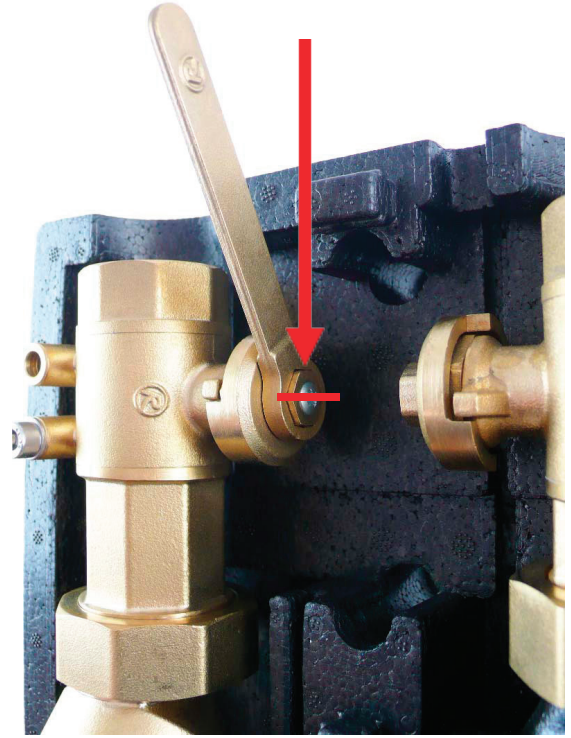

groove perpendicular to the flow direction

4. EXAMPLES OF PUMP STATION CONNECTION

CSE2 MIX

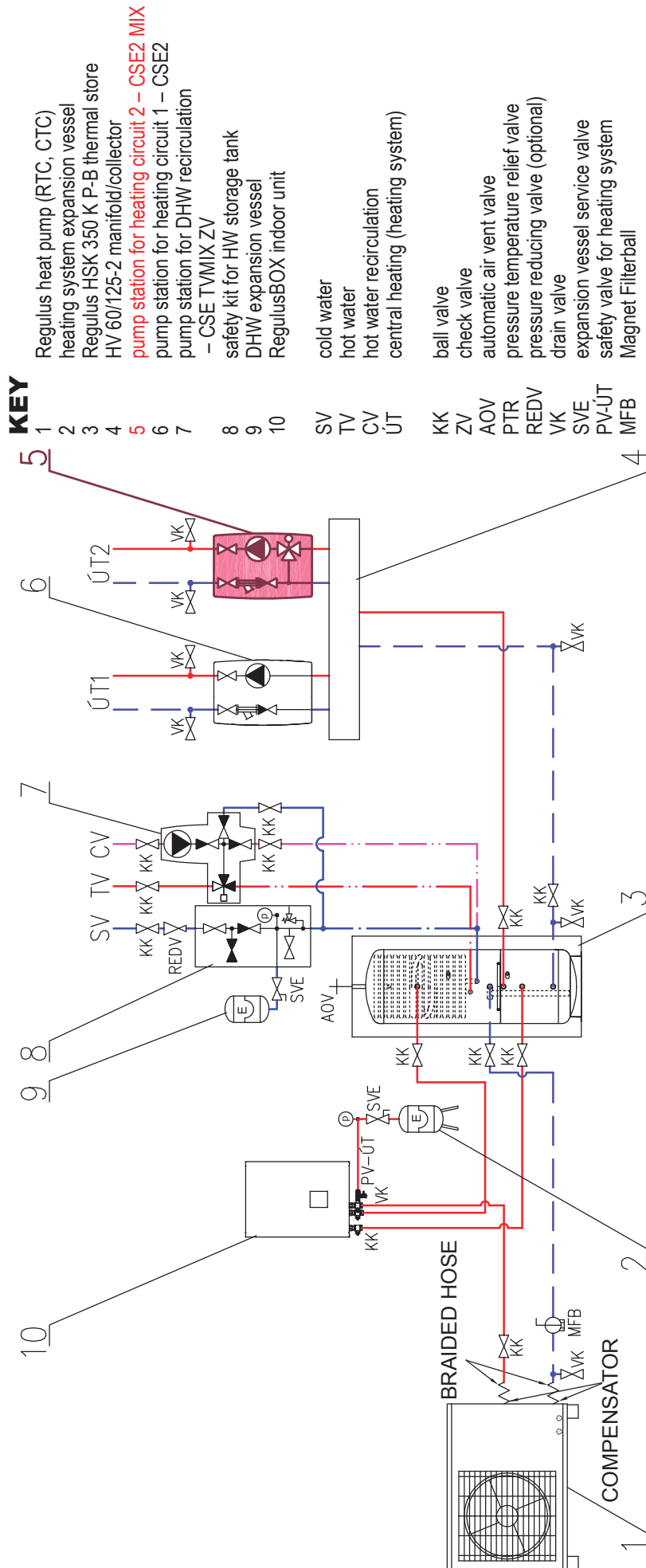

CSE2 MIX

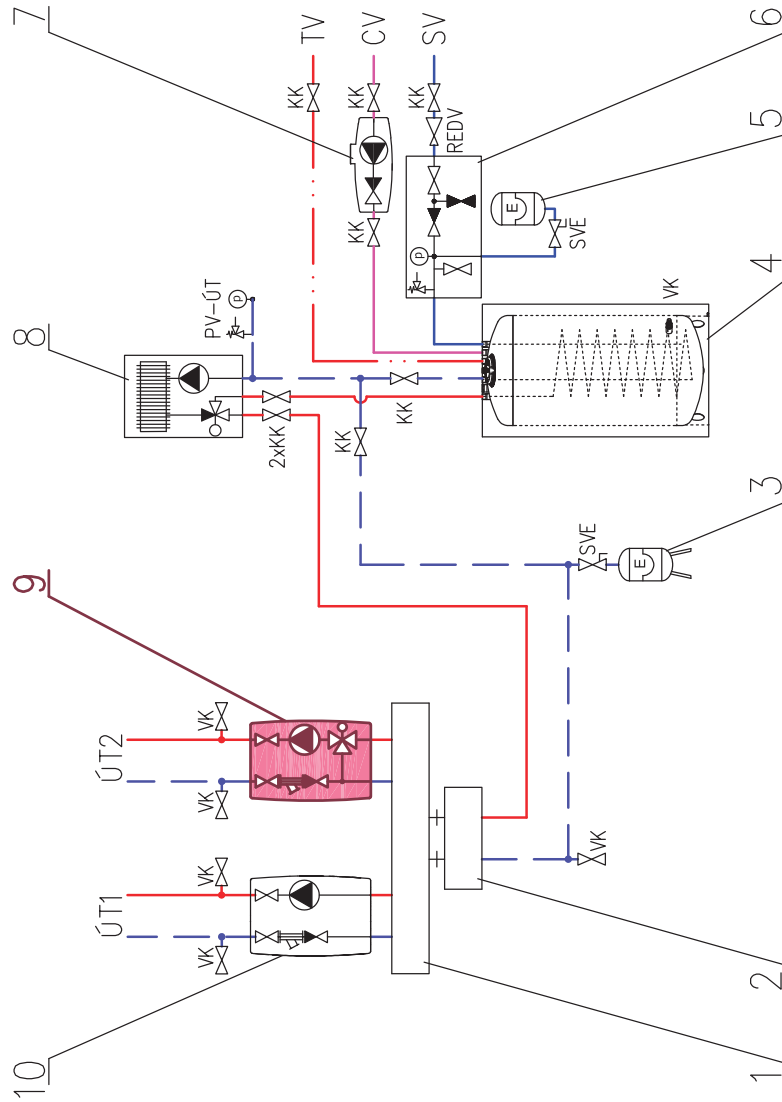

KEY

- | | |
|-------|--|
| 1 | HV 60/125-2 manifold/collector |
| 2 | hydraulic pressure balancer |
| 3 | heating system expansion vessel |
| 4 | hot water storage tank (e.g. NBC 170 HP) |
| 5 | DHW expansion vessel |
| 6 | safety kit for HW storage tank |
| 7 | pump station for DHW recirculation – CSE TV ZV |
| 8 | boiler (natural gas, electric...) |
| 9 | pump station for heating circuit 2 – CSE2 MIX |
| 10 | pump station for heating circuit 1 – CSE2 |
| SV | cold water |
| TV | hot water |
| CV | hot water recirculation |
| ÚT | central heating |
| KK | ball valve |
| ZV | check valve |
| AOV | automatic air vent valve |
| PTR | pressure temperature relief valve |
| REDV | pressure reducing valve (optional) |
| VK | drain valve |
| SVE | expansion vessel service valve |
| PV-ÚT | safety valve for heating system |
| MFB | Magnet Filterball |

5. PUMP STATION INSTALLATION

The pump station is designed to be mounted on a wall or a manifold with 125 mm connection pitch. In the rear section of the insulation there are two mounting holes for fixing the metal plate to the wall. Mounting holes pitch is 80 mm.

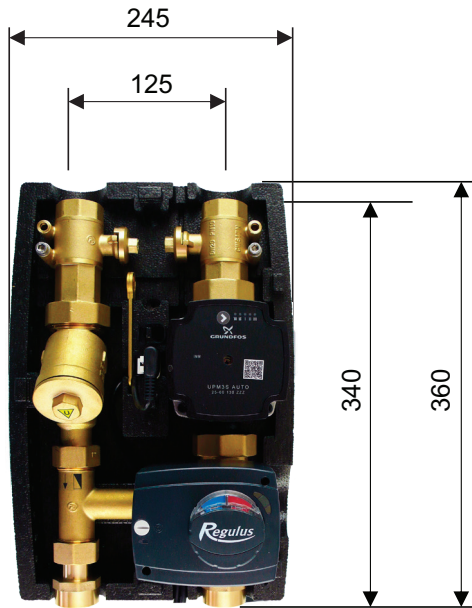

Installation dimensions are shown in the figure.

The package includes a mounting kit that is used to fix the pump station to the intended place. The mounting kit includes:

- Screw 5x50, round head 2 pcs
- 6.4 stainless steel washer, DIN 9021/A2 2 pcs
- Wall plug 8mm TX 2 pcs

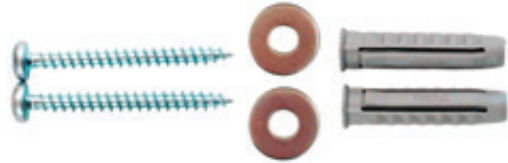



Permitted and prohibited positions of the pump station

Permitted position	Conditionally permissible positions (may be used when a filter is replaced by the filter replacement section, code 19017)	Prohibited position
--------------------	--	---------------------

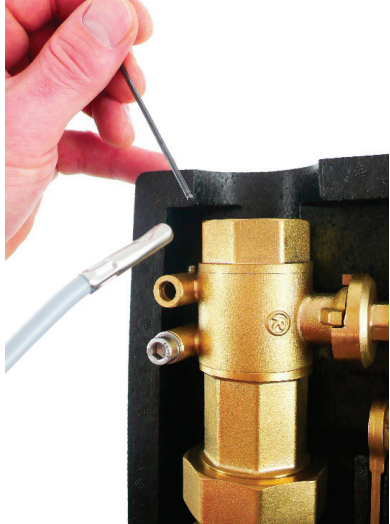

6. TEMPERATURE SENSOR INSTALLATION

The ball valve housings are equipped with a sheath for the temperature sensor, where the sensor can be inserted and secured by a fixing screw against being pulled out. In the top and bottom section of the insulation there are passages to run the cables through, then it is necessary to cut the appropriate part of the passage lock from the front part of the insulation with a knife, so that the exiting cables are firmly wrapped around by the lock.

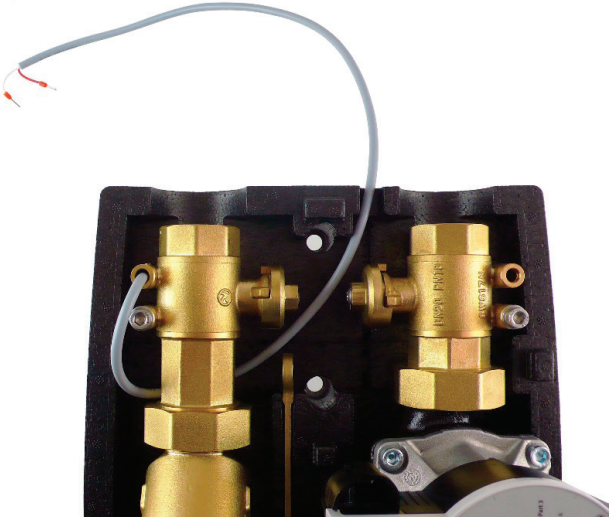
<p>1. Temperature sensor placement</p>	
<p>2. Securing the temperature sensor with the screw</p>	
<p>3. Running the sensor cable through the recess in the insulation</p>	

4.
Trimming the cable passage lock

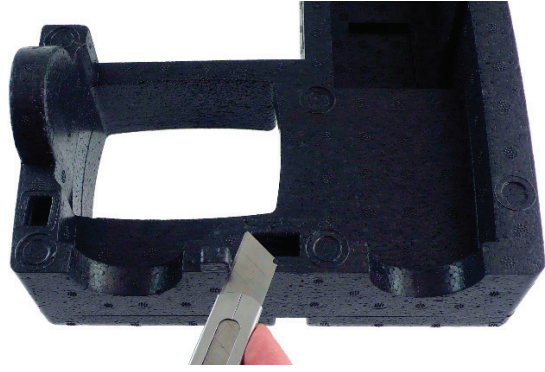

5.
Installed sensors



7. OPTIONAL ACCESSORIES

The following optional accessories are available for the pump station:

A – Filter replacement section for CSE2 Code 19017



Loosen the unions above and under the filter.



Remove the filter and mount the filter replacement section (code 19017) in its place.



**B – Ball Valve w. drain valve, Fu/F
Code 17415
and Union 1“ Fu/M incl. gasket
Code 15695**



Remove both the connecting fittings.



Install the union 15695 in their place, then attach the ball valve w. drain valve (17415) to the union.



C – Union, 1" Fu/M, extended, with check valve, incl. gasket
(for return line of CSE2 pump stations)

Code 18653

and **Union, 1" Fu/M, extended, incl. gasket**
(for flow line of CSE2 pump stations)

Code 18797

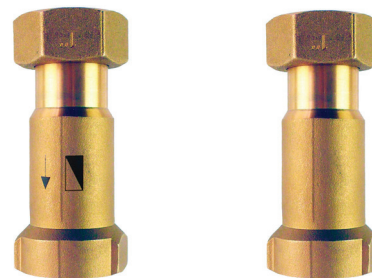

Remove both the connecting fittings.



Install the extended union with check valve (18653) to the return line.



Install the extended union (18797) to the flow line.



**D – Union to connect CSE2 to 5/4” manifold - 1“x5/4“ Fu/F
Code 17920**



Remove both the connecting fittings.



Replace them with the union 17920 intended for connection to a manifold.



APPENDIX – ACTUATOR ADJUSTMENT

- The actuator is set and ready for operation from the production
- The instructions apply only if the actuator had to be removed e.g. to be replaced

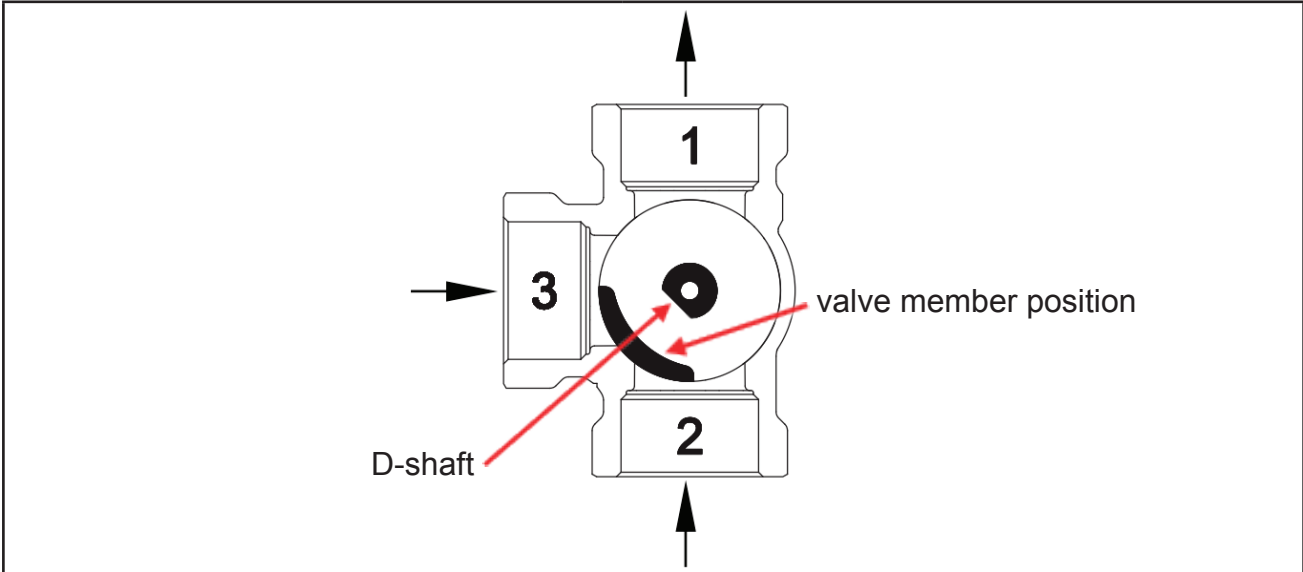

1.
When fitting the actuator, turn the D-shaft in such a manner that the valve member is between inlets 2 and 3 at an angle of 45°.

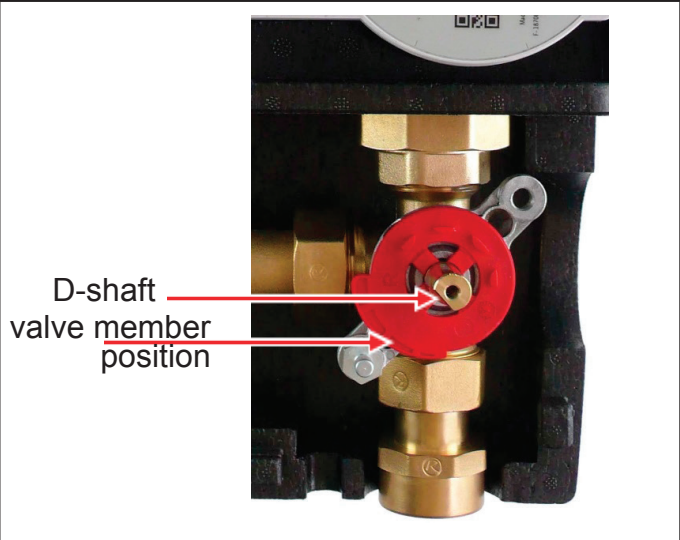

2.
Fit the plastic adapter on the shaft. The flat edge of the shaft and the arrow on the plastic adapter are located on the same side as the valve member.

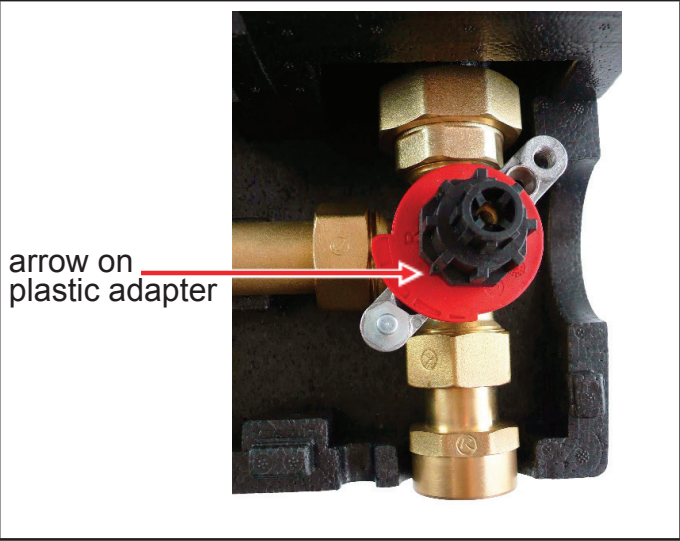

3.
Prior to fitting the actuator on the plastic adapter, switch it to manual control, set the control knob exactly to the middle of its movement range.

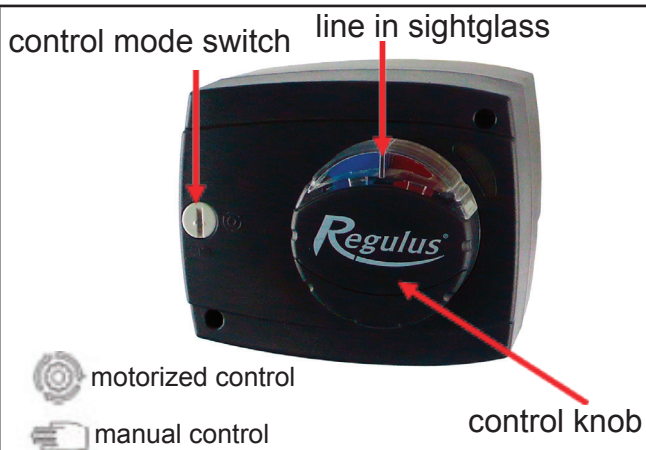

4.
Fit the actuator onto the plastic adapter. Check its turning: the control knob shall be able to turn freely both to left and right by 45° (when turned to the right by 45° the path 3 is closed, and when turned to the left by 45° the path 2 is closed). Having performed the check, tighten the fastening screw and switch back to motorized control.

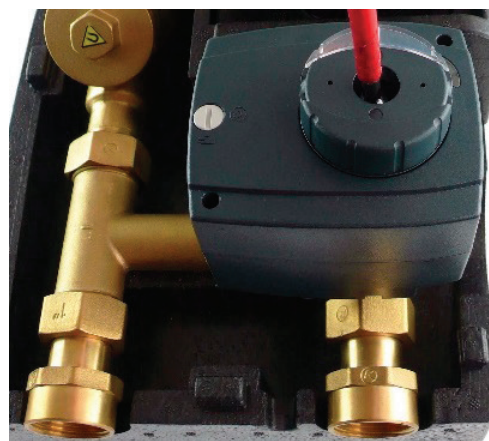

5.
The actuator shall be installed in the same manner as in the figure.

