



RGMAT EA G60

Installation and Operation Manual
**Regulus RGMAT EA G60 LOAD UNIT with UPM 3, insulated
for heating systems**

EN

1. Introduction

RegulusRGMAT EA G60 Load Unit makes boiler installation quicker as it contains all components needed for boiler circuit circulation and for boiler protection against low-temperature corrosion. It is designed to be installed directly on a boiler return piping. The distance of pipe axis from a wall shall be at least 100 mm to enable insulation removal if needed.

This Load Unit is intended for hydronic fireplaces and solid-fuel boilers.

2. RGMAT EA G60 Description

RGMAT EA G60 keeps the temperature in a hydraulic boiler circuit above the flue gas condensation temperatures, which prevents so called low-temperature corrosion of the boiler combustion chamber. This limits condensation and boiler tarring significantly, the efficiency of fuel combustion increases and service life of the boiler is extended.

Main features	
Function	maintaining stable inlet temperature into a boiler (fireplace) through a load valve
Application	Load Unit for solid-fuel boilers and fireplaces; it prevents low-temperature corrosion and boiler (fire) fouling
Description	consists of a UPM 3 FLEX AS pump, ball valves with union nuts, TSV3 valve (with manual bypass balancing), thermometer, insulation
Working fluid	water; water/glycol mixture (max. 1:1) or water/glycerine mixture (max. 2:1)
Installation	on return piping, min. distance of the pipe axis from a wall is 100 mm; for proper operation it is necessary to install and adjust a valve at the B inlet to balance flowrate

Code	Max. boiler output
19087 for opening temperature 72 °C	max. 25 kW at ΔT 20 K and fully open balancing valve
19084 for opening temperature 65 °C	max. 25 kW at ΔT 20 K and fully open balancing valve

RGMAT EA G60 Technical Data	
Fluid operating temp.	5 - 95 °C
Max. working pressure	6 bar
Min. working pressure	0.5 bar
Ambient temperature	5 - 40 °C
Max. rel. humidity	80 %, non-condensing
Power supply	230 V, 50 Hz
Insulation material	EPP RG 60 g/l
Overall dimensions	325 x 140 x 220 mm
Total weight	3.25 kg
Connections	3 x G 1" F

Accessories	
Bypass with non-return valve	code 16 126

3. RGMAT EA G60 Connection Diagram

Example of possible connection I.

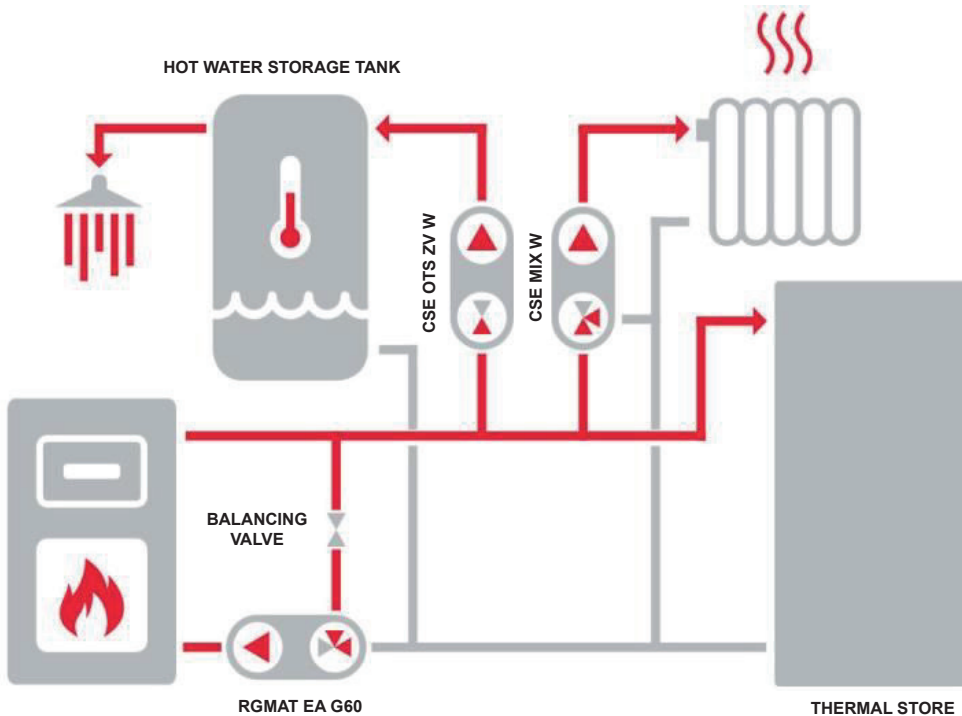

The diagram shows a typical connection of a solid-fuel boiler, thermal store and a heating circuit (with a recommended CSE MIX W pump station - not included in supply). If the boiler is also used for DHW heating, it is recommended to install also CSE OTS ZV W pump station (not included in supply). A balancing valve shall be installed at the B inlet to the RGMAT EA W6 load unit.

Example of possible connection II.

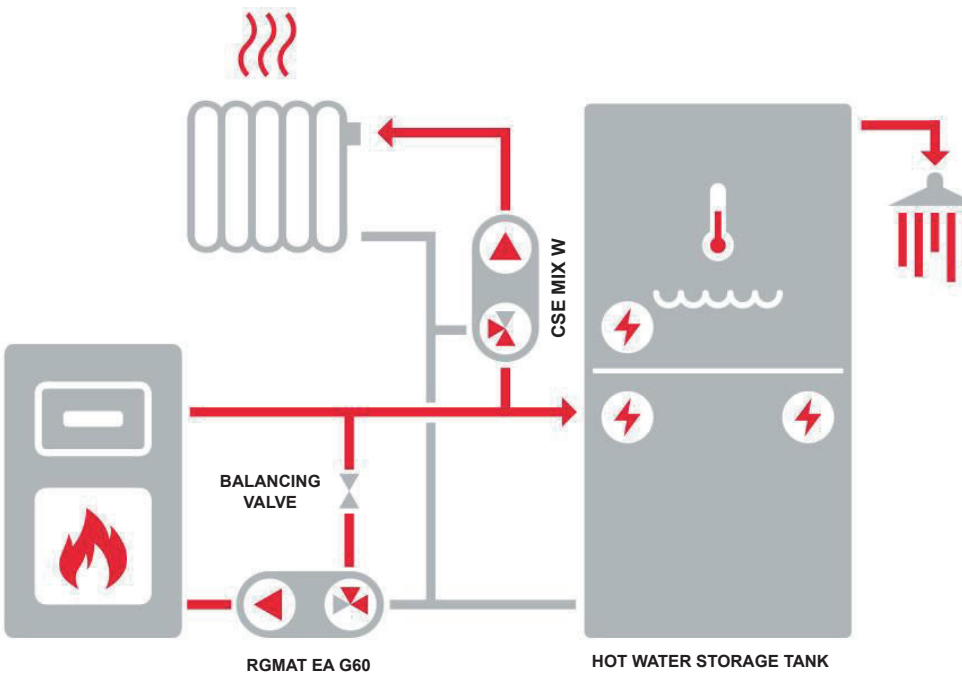

The diagram shows a typical connection of a solid-fuel boiler, combination thermal store and a heating circuit (with a recommended CSE MIX W pump station - not included in supply). A balancing valve shall be installed at the B inlet to the RGMAT EA W6 load unit.

Install the Load Unit respecting the following instructions:

Connect the Load Unit outlet marked **AB** to the piping entering the boiler. Connect the return line from the heating system to the **A** inlet, and the outlet pipe from the boiler to the **B** inlet via a T-piece. Take care to install shut-off valves where necessary to avoid draining the whole system for valve cleaning or replacing the thermostatic element.

When the connecting pipes are not arranged or sloped properly, the thermostatic valve may get blocked by air inside. This may hinder or even disable its operation.

Always respect valid rules and boiler manufacturer's data during installation.

4. Function description and balancing the TSV3 valve

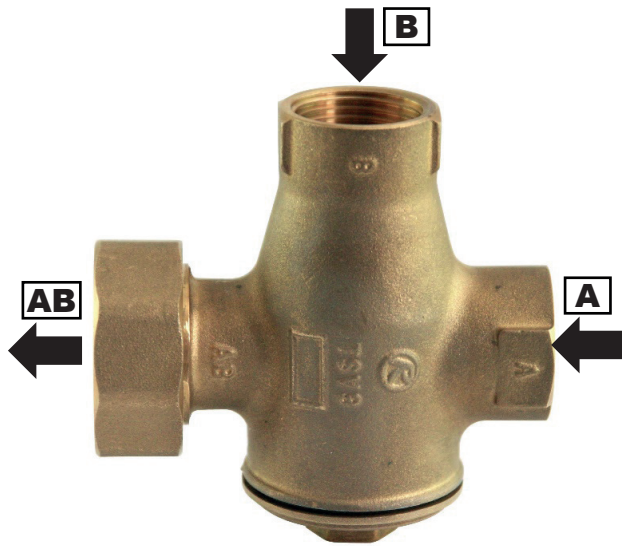

The TSV3 load valve is fitted with an integrated thermostatic insert that will close the **A** inlet (from a heating system), if the return water temperature to the boiler (**AB** outlet) is lower than the opening one. As soon as the opening temperature is reached, the thermostat starts opening the **A** inlet slowly and mixing the cold return water with the hot water from the **B** inlet (boiler flow) with the aim to reach the return temperature (**AB** outlet) slightly higher than the valve's opening temperature. The **B** inlet remains always open. However, since the **B** inlet remains permanently open, it may happen depending on the hydraulic conditions that under a higher return temperature more hot water will be mixed from the **B** inlet than necessary for reaching the an optimum temperature at **AB** outlet. Under these conditions, the return water temperature will be unnecessarily high. In order to set the

optimum flow rate for a specific application, a balancing valve shall be fitted before the **B** inlet (e.g. a plain ball valve is sufficient). Its size can be two sizes down from the dimension of **B** inlet (like the entire piping between the Tee at the boiler outlet and the **B** inlet), however not bigger than the piping at the **AB** outlet.

Adjusting the balancing valve:

a. Set the valve to fully open for the first firing. Immediately after firing up, before the return line reaches the opening temperature of the TSV3 valve, set the balancing valve to half open. Let it partially open in such a way that at least the min. flow required by the boiler manufacturer passes through the boiler (usually this corresponds to a temperature drop at the boiler of 20-30 °C at full power). Monitor the boiler flow temperature, it must not exceed the max. operation temperature during the entire temperature ramp, nor after the full output is reached with nominal return temperature. Should the flow temperature rise too high, open the valve a bit more.

b. If the temperature at the **AB** outlet is higher, adjust the valve towards closed. In case the valve cannot be set properly, check the hydraulic system of the system for undesired counter-pressures from another pump or from other wrong connections in the system. Also check that the circulation pump after the **AB** outlet of the valve is set to full power and its performance is suitable for the boiler output.

It is recommended to remove the lever of the balancing valve after balancing in order to avoid possible unintentional shut-off or other movement of the lever.

TSV3 thermostatic mixing valve offers fully automatic operation, needs no el. energy, operator or maintenance. When the valve gets clogged with impurities from the system or in case of its breakdown, first close the ball valves on all connecting pipes in order to avoid draining the system. Then loosen the plug using spanner #21 or another suitable tool. Take out the pressure spring of the element and the thermostatic element itself. When re-assembling the valve, take care of the thermostatic element's perfect fit to the gasket with its entire contact surface and its spring being centred within the plug.

TSV3 Valve

Technical Data	
Valve opening temperature	depending on the thermostatic element
Control range	$t_{\text{valve opening}} + 5 \text{ }^{\circ}\text{C}$
Valve Kvs (A→AB direction)	6.2 m ³ /hod
Valve Kvs (B→AB direction) *	10.1 m ³ /h
Nominal inner diameter	DN 25

* when the balancing valve is fully open

Materials	
Housing, cone and plug	brass
Spring	stainless steel
Gasket	EPDM

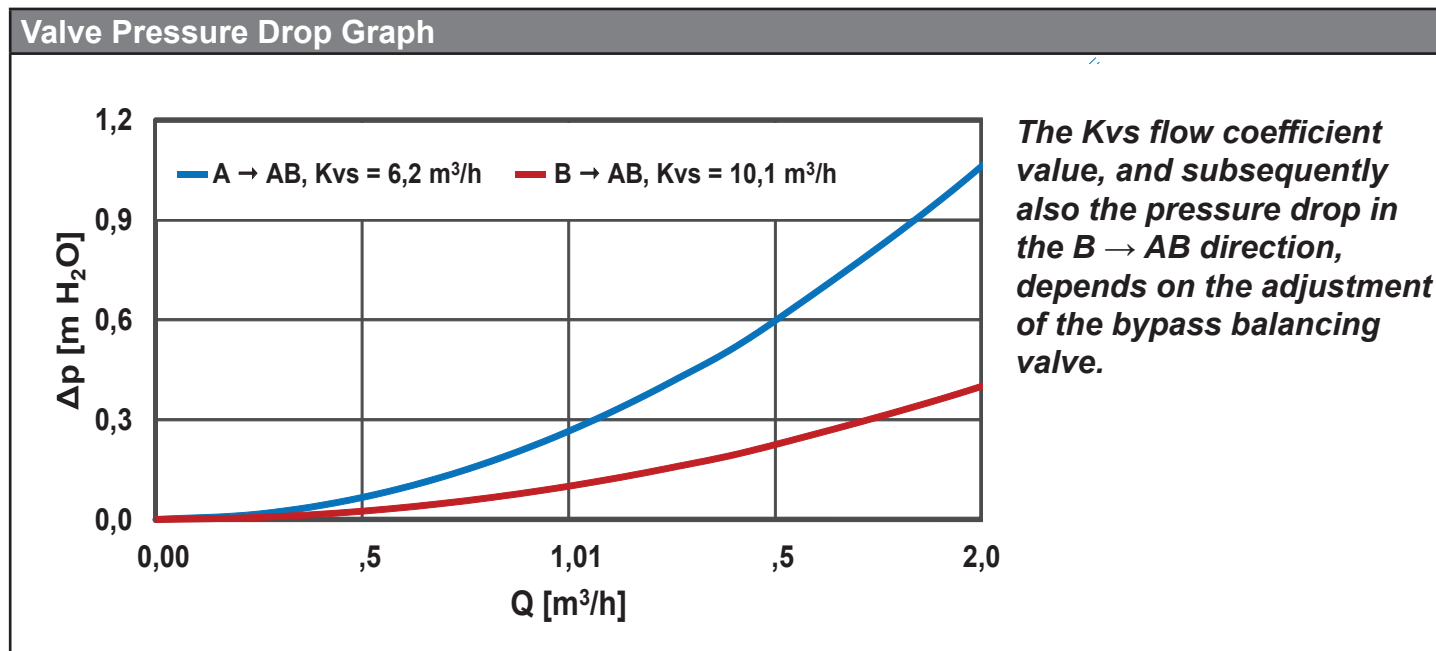

5. UPM3 FLEX AS 25-60 180 Pump Design

Wet-running circulation pump with G 6/4" M connection.

Electrical Data	
Power supply	230 V, 50 Hz
Power consumption (min./max.)	2/42 W
Current (min./max)	0.04/0.40 A
IP rating	IP44
Max. speed	5288 rpm
Weighted average power	≤ 20 W
Energy Efficiency Index	≤ 0.20 by EN 16 297/3
Motor protection	not needed



Pump control

The circulation pump can be controlled by an external PWM signal (profile for use in heating systems) or without a PWM signal by selecting a pump performance curve.

A maximum curve of a pump working range can be defined.

- with PWM signal the pump speed changes with the signal value up to the maximum of the selected curve
- without PWM signal the pump runs at the max. speed according to the selected curve

Performance Curves

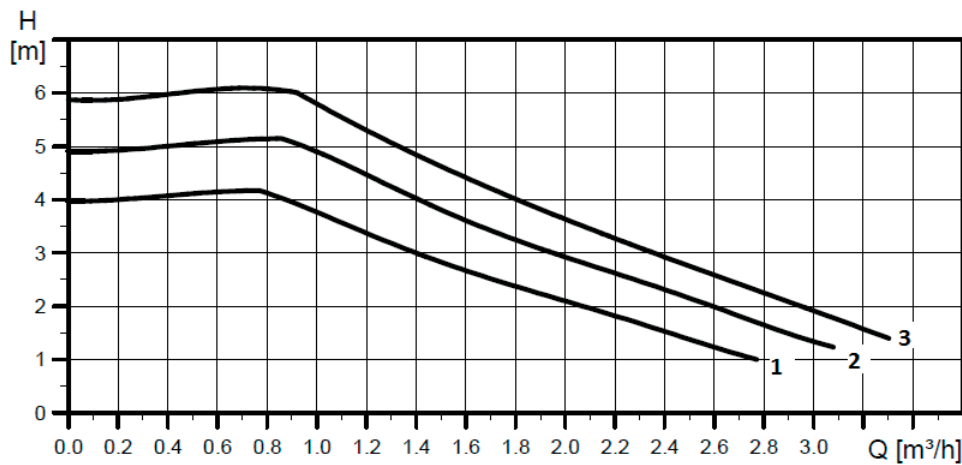

Curve	Max. H (upper graph)	Max. P ₁ (lower graph)
1	4 m	25 W
2	5 m	34 W
3	6 m	42 W

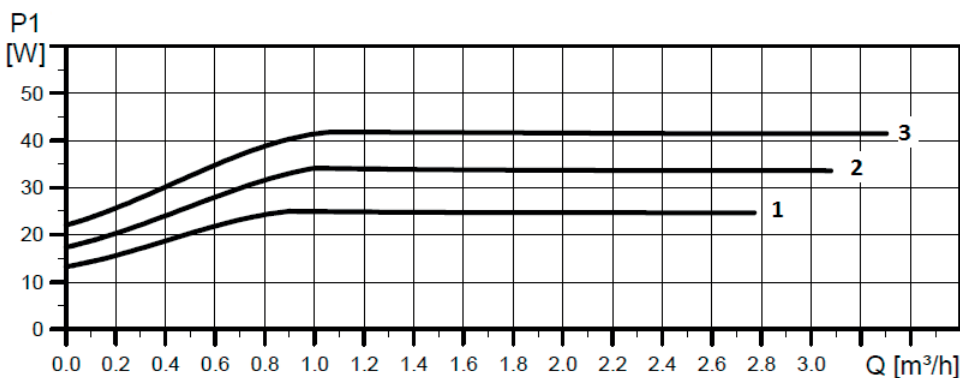

Performance Display

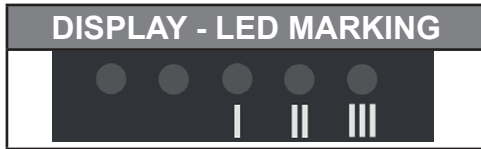

The LED marking is further omitted for better clarity.

DISPLAY	PERFORMANCE CURVE	STATE	Max. H _(upper graph)
	1	LOW PERFORMANCE	4 m
	2	MEDIUM PERFORMANCE	5 m
	3	HIGH PERFORMANCE	6 m

WARNING: LEDs may be mirrored, depending on the specific pump type.

GREEN LED FLASHING FREQUENCY	PWM SIGNAL RECEPTION
1 flash per second	NO
12 flashes per second	YES

When switched on, the pump runs at factory settings or the last setting. The display shows the current pump performance.

Setting selection for UPM3

When switched on, the pump runs at factory settings or the last setting. The display shows the current pump performance.

Error Display

DISPLAY	CONTROL MODE
	Seized pump
	Too low power supply voltage
	Electric fault

Forbidden positions

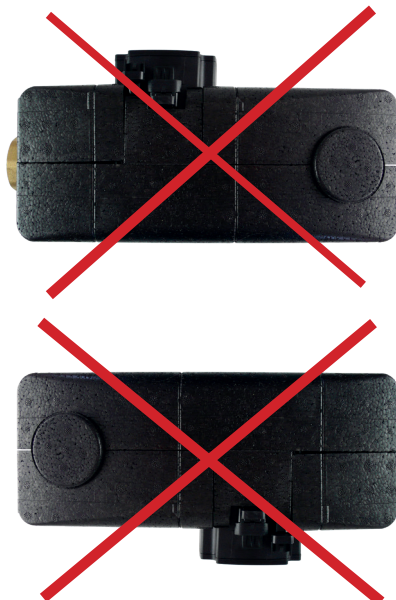

Permissible positions



Pump wiring

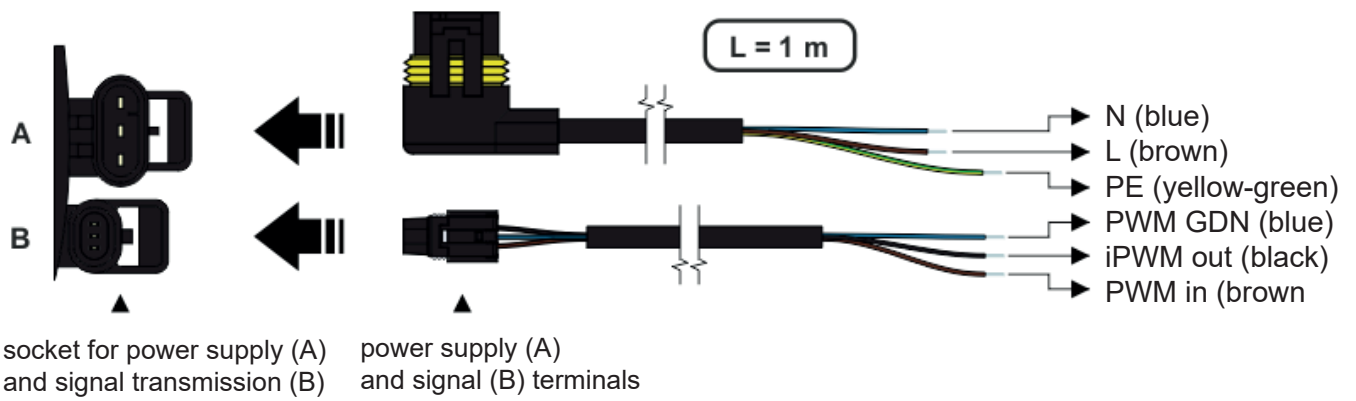

6 . Installation options

This Load Unit comes in the version for horizontal installation to the right of a boiler. However, it can be installed also into vertical piping or horizontally to the left of a boiler. When being installed horizontally to the left of a boiler, the Load Unit needs to be turned by 180° and the TSV3 valve turned as shown in the pics below.

