



[www.regulus.eu](http://www.regulus.eu)



CSE MIX G 5/4M

Installation and Operation Manual  
**CSE MIX G 5/4M PUMP STATION**  
with mixing valve

**EN**

**CSE MIX G 5/4M**

# 1. Introduction

CSE MIX G 5/4M pump station is designed to be installed in heating circuits where it provides heating water mixing and circulation through the circuit. Its typical application is in mixed heating circuits in buildings where it provides circulation and mixing of heating water to a desired temperature, or for solid-fuel boiler circuits where it provides circulation and mixing to a min. heating water temperature as a protection against low-temperature corrosion. Actuator of the mixing valve is controlled by an external controller through 3-point control with 230V outputs. The circulation pump is switched by an external controller with a 230 VAC output. The controller is not included in supply.

The pump station is designed to be installed directly on the pipe, with 100 mm min. distance of the pipe axis from a wall.

## 2. Description of the pump station

The pump station consists of a UPM3 pump including power and control cables, a 3-way mixing valve with actuator incl. a power cable, a ball valve and insulation.

Main features	
Application	control of a solid fuel boiler return line temperature or control of flow temperature into a mixed circuit by an external controller
Description	consists of a UPM3 Flex AS 25-75 130 pump, a 3-way mixing valve LK 840 with AVC actuator and insulation
Working fluid	water, water-glycol mixture (max. 1:1) or water-glycerine mixture (max. 2:1)
Instalace	return pipe of a solid fuel boiler / flow pipe into a heating circuit, the min. distance of the pipe axis from a wall is 100 mm
<b>Code</b>	<b>16 847</b>

Technical data of CSE MIX G 5/4M pump station	
Fluid working temperature	5 - 110 °C
Max. working pressure	10 bar
Ambient temperature	5 - 40 °C
Max. rel. humidity	95 % non condensing
Power supply	230 V, 50 Hz
Insulation material	EPP RG 60 g/l
Overall dimensions	325 x 140 x 220 mm
Total weight	3.9 kg
Connections	2 x G5/4" M, 1 x G5/4" F

### 3. Installation options

The pump station comes with a mixing valve in the left-hand position (see Fig. 1). If this installation position is convenient, there is no need to make any adjustments. When needed, the mixing valve can be rotated to the right-hand position (see Fig. 2). After the valve is turned by 180° and the fittings tightened, the actuator lock shall be unscrewed and screwed into the opening at the other valve side (see Fig. 3) and the position of the valve member and actuator changed (see the paragraph and pictures below).

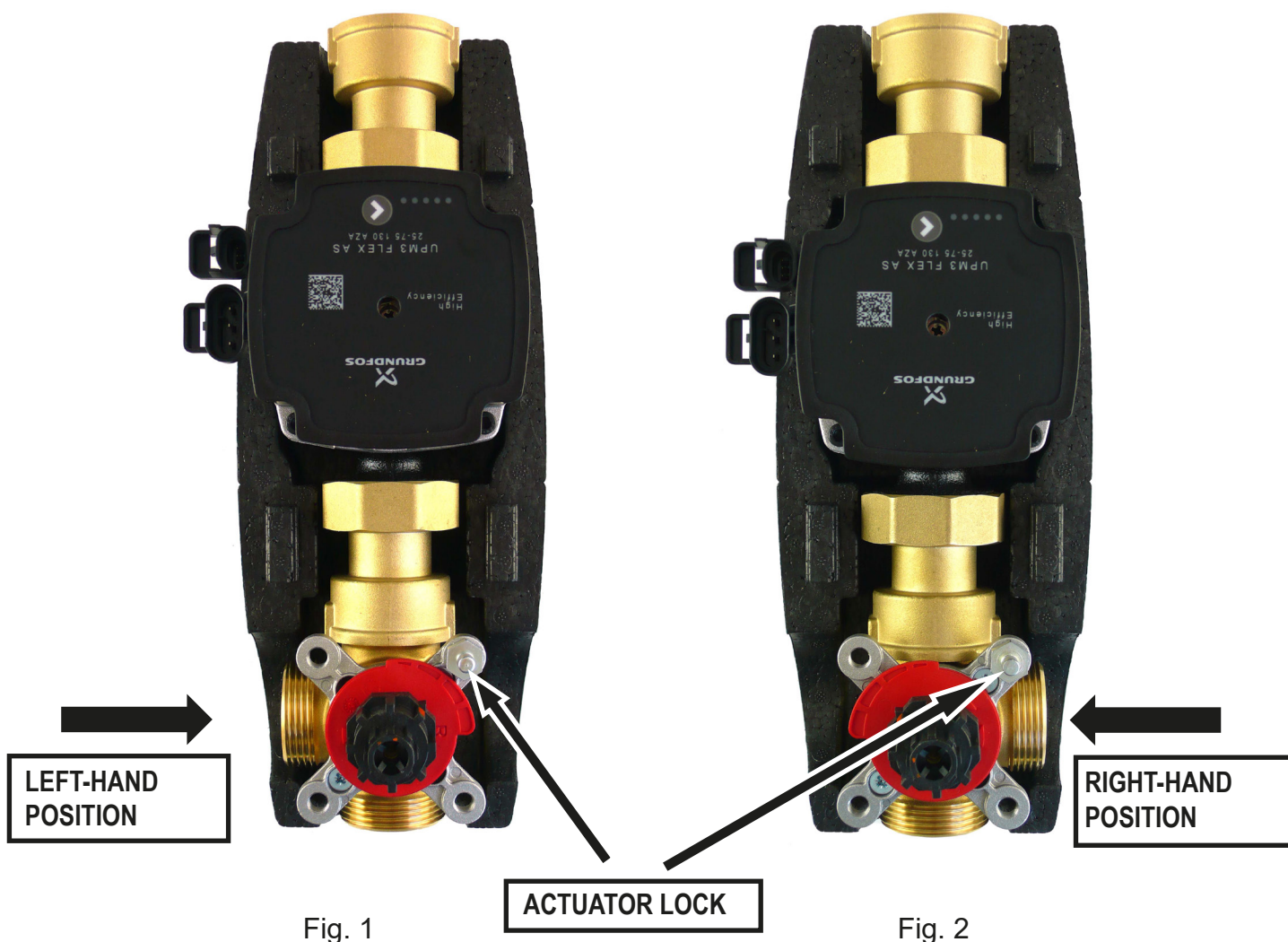

Fig. 1

Fig. 2

## Actuator adjustment

Having turned the valve to the right hand position, turn the D-shaft in such a manner that the valve member is between inlets 1 and 3, turn the plastic red wheel into its proper position (see Fig. 4), and finally fit the plastic adapter (see Fig. 4).

**The flat edge of the shaft and the arrow on the plastic adapter are located across from the valve member!**

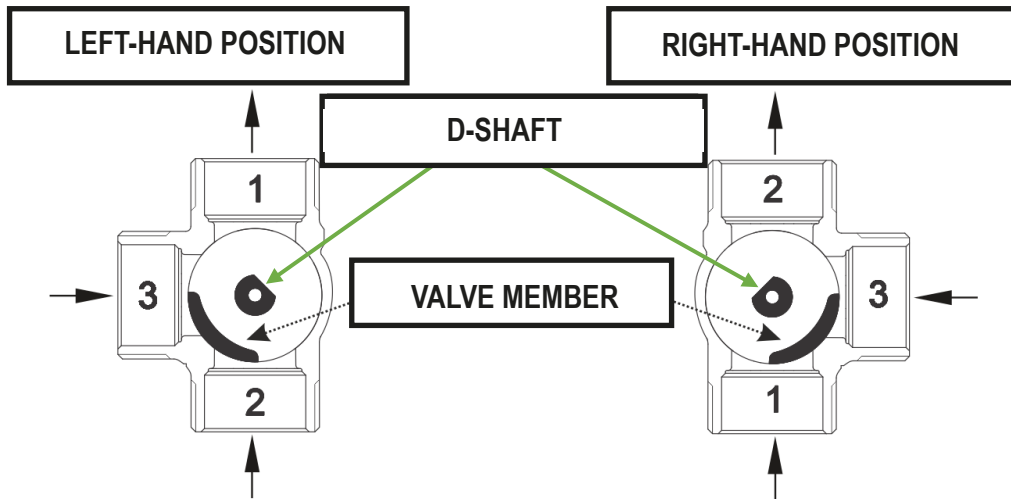
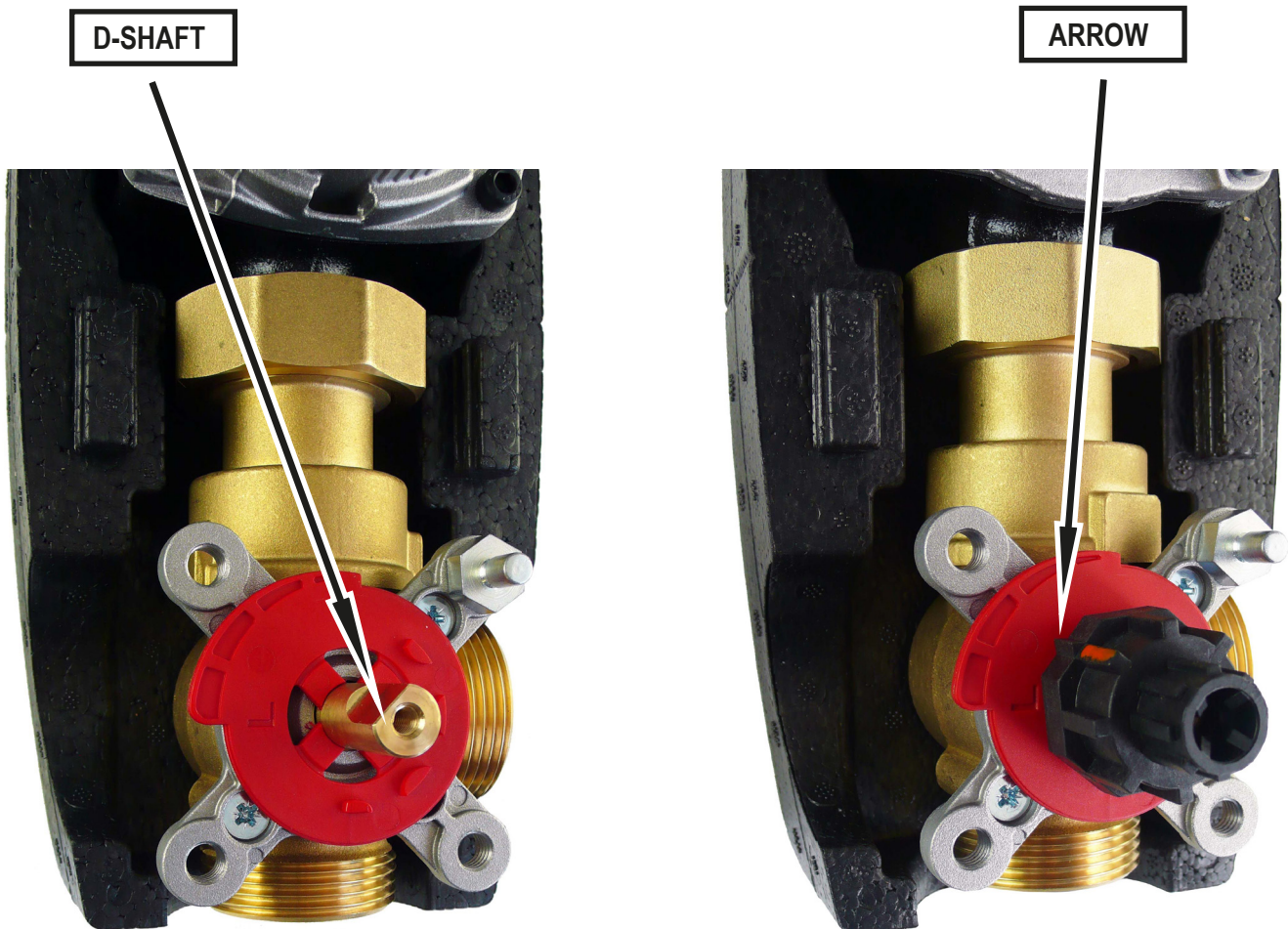

Fig. 3



obr. 4



Prior to fitting the actuator on the plastic adapter, switch it to manual control, set the control knob to the middle of its control range and then fit the actuator onto the adapter already on the valve. The control knob shall be able to turn freely both to left and right by 45°. When turned to the right by 45°, the path 1 is closed, and when turned to the left by 45° the path 3 is closed. Having performed the check, turn the knob back to automatic control.

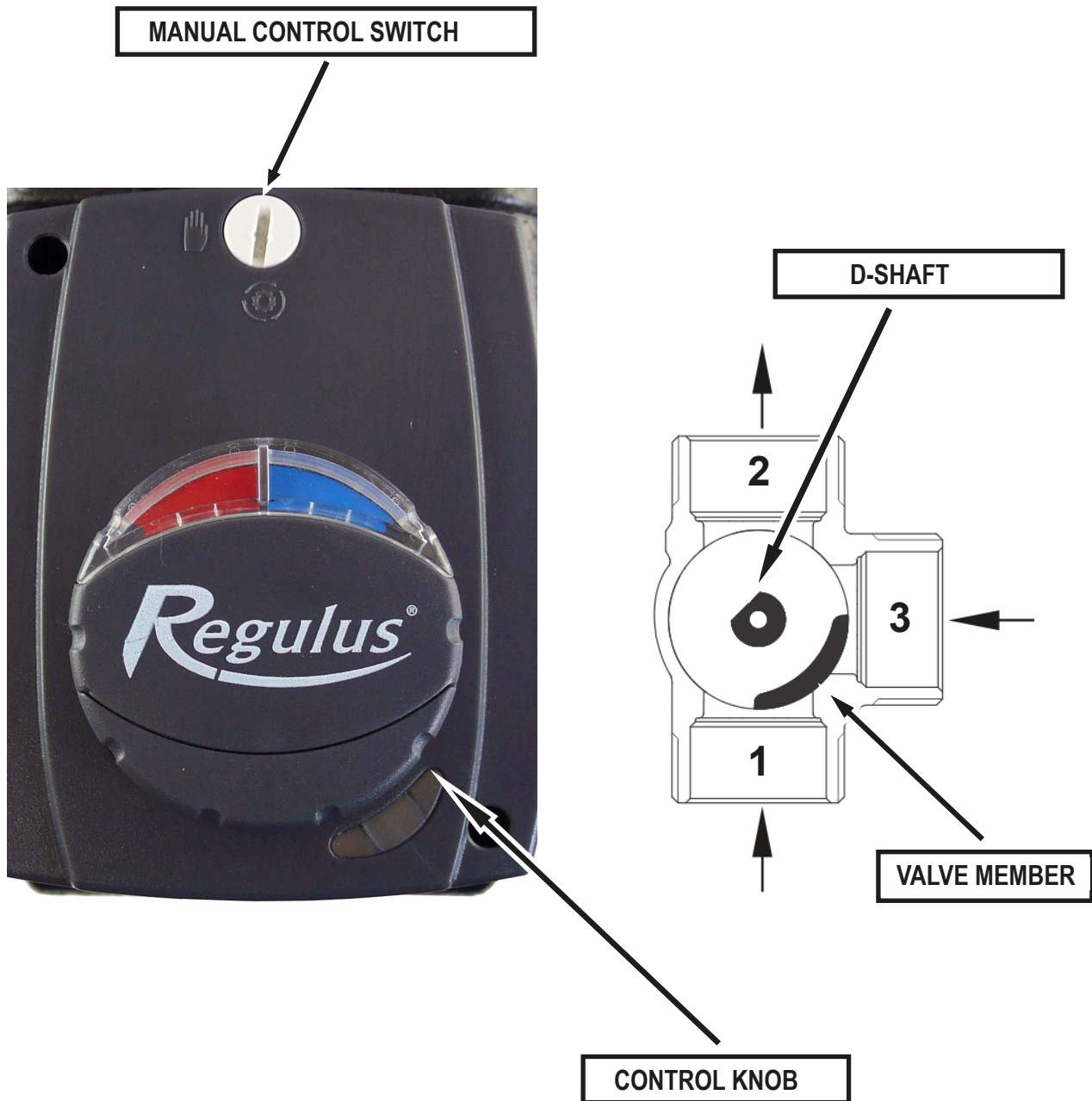

After the actuator is fitted, the correct position of the round indication label (hot/cold, red/blue) shall be checked as to the right function and position of the valve.  
In case of a vertical installation in central heating, the red mark on the label shall be on the right-hand side for left-hand installations (see Fig. 5) and on the left-hand side for right-hand installations (see Fig. 6).



Fig. 5



Fig. 6

In case of a horizontal installation with a solid fuel boiler, the red mark on the label shall be on the right-hand side for right-hand installations (boiler to the left from the pump station, see Fig. 7) and on the left-hand side for left-hand installations (boiler to the right from the pump station, see Fig. 8).



Fig. 7



Fig. 8

## 4. Pump Station Connection Diagram

The pump station may be installed in either horizontal or vertical position.

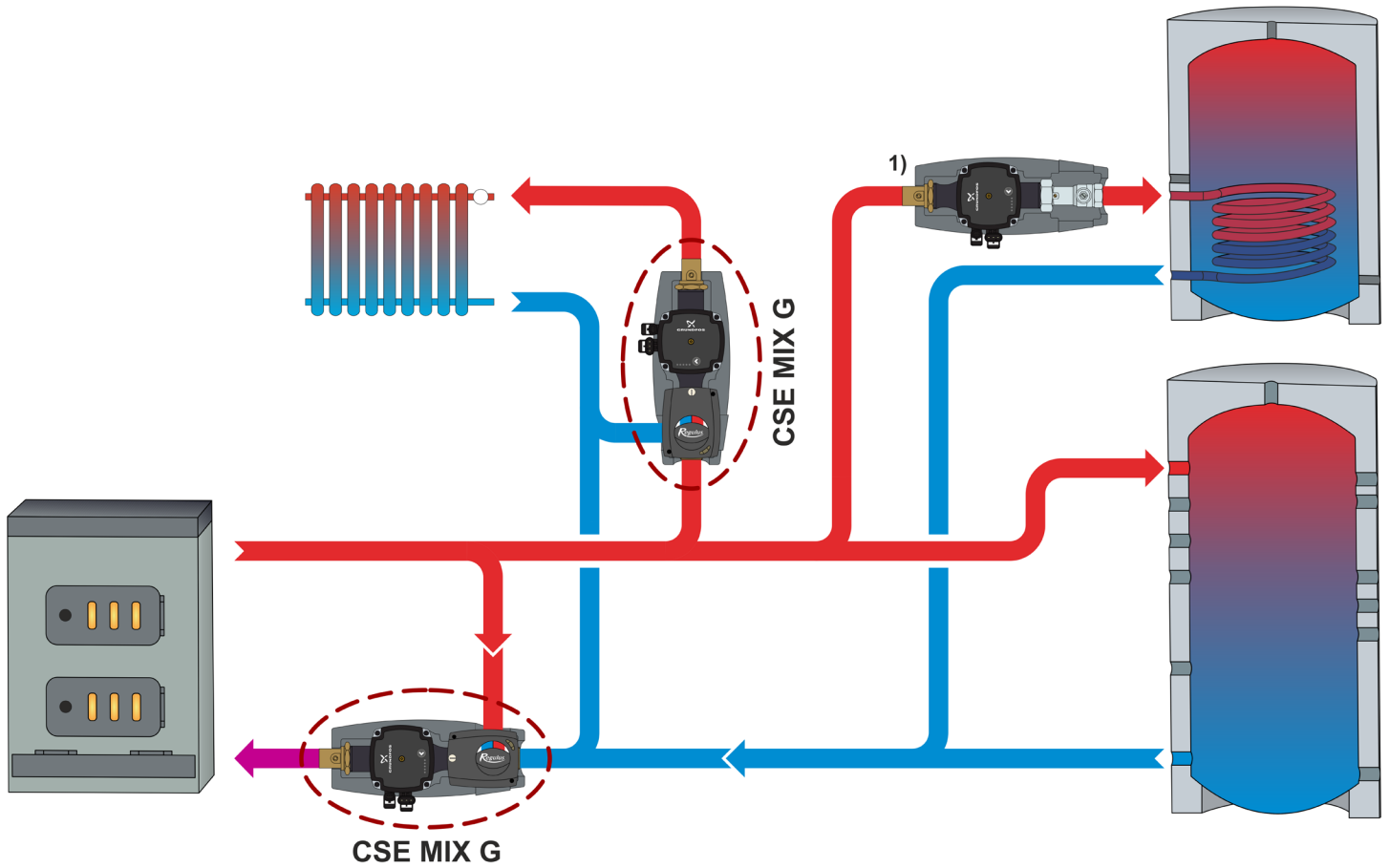

1) CSE OTS ZV G - Code 15042

## 5. LK Mixing Valve

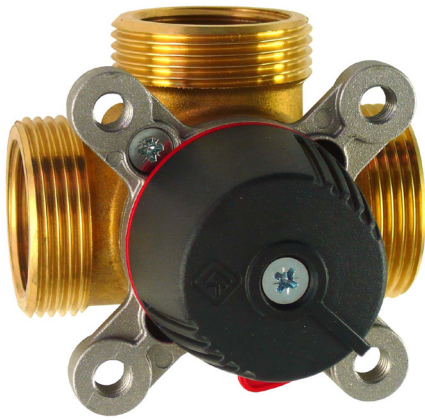

Technical data	
Working temperature	5 - 110 °C (120 °C in short term)
Max. working pressure	10 bar
Ambient working temperature	5 - 60 °C
Valve $K_{vs}$	12 m <sup>3</sup> /h
Max. pressure difference	5 m H <sub>2</sub> O
Leakage rate	< 1% $K_{vs}$ at 5 m H <sub>2</sub> O pressure difference
Connections	3 x G 5/4" M

Materials	
Valve housing, spindle, member	brass
Seal	EPDM

Valve pressure drop graph

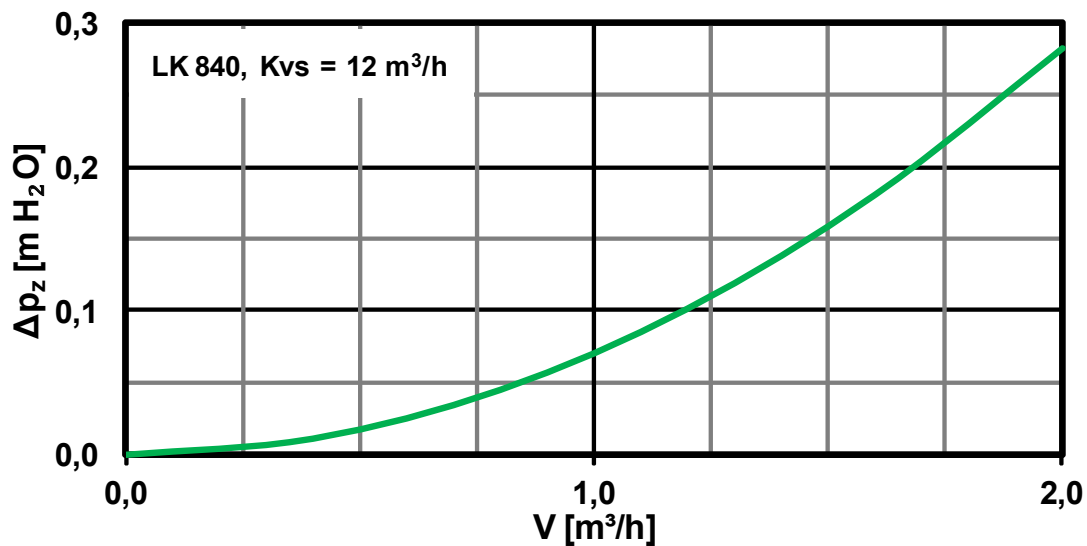



## 6. Mixing Valve Actuator



Technical data	
Torque	5 Nm
Angle of rotation	90°
Shift time	120 s
Control	3-point
Auxiliary switch	none
Power supply	230 V AC
Max. power input	2.5 VA
IP rating	IP42
Protection class	II by EN 60730-1
Ambient temperature	0 - 40 °C
Cable (cross section area - length)	3 x 0.5 mm <sup>2</sup> - 2 m

### actuator wiring

- marking 1, 2, 3 located on the cables

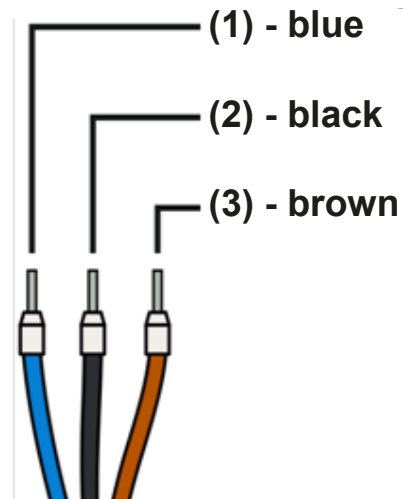
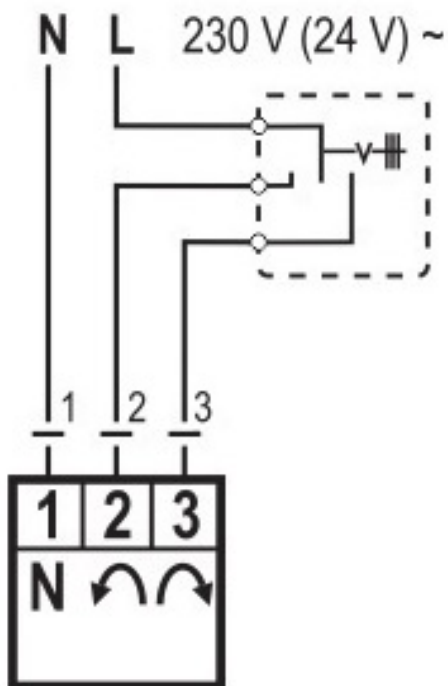

## 7. UPM3 FLEX AS 25-75 130 mm Pump

### Design

Wet-running circulation pump with G 6/4" M connection.

Electrical data	
Power supply	230 V, 50 Hz
Power input (min./max.)	2/60 W
Current (min./max.)	0.04/0.58 A
IP rating	IP44
Max. speed	5991 rpm
Weighted average power	≤ 28 W
Energy Efficiency Index	≤ 0,20 by EN 16 297/3
Motor protection	not needed

Minimum pressure at the suction port	
Min. pressure at the suction port to avoid cavitation	0.05 bar at 75 °C
	0.50 bar at 95 °C
	1.08 bar at 110 °C



### Pump control

The circulation pump can be controlled by an external PWM signal (profile for use in heating systems) or without a PWM signal by selecting a pump performance curve.

A maximum curve of a pump working range can be defined.

- with PWM signal the pump speed changes with the signal value up to the maximum of the selected curve
- without PWM signal the pump runs at the max. speed according to the selected curve

### Performance curves

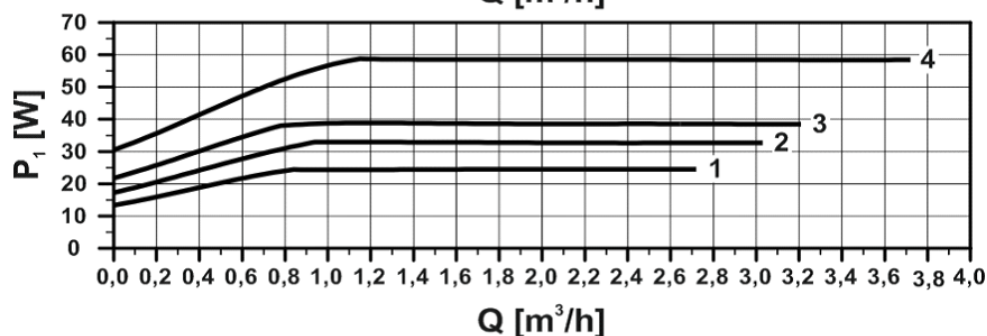
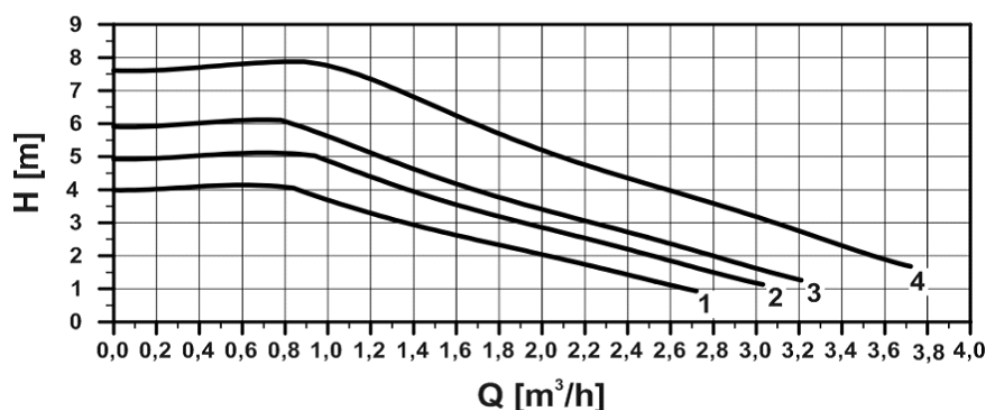

Curve	Max. H (upper graph)	Max. P <sub>1</sub> (lower graph)
1	4 m	25 W
2	5 m	33 W
3	6 m	39 W
4	7.5 m	60 W

## Performance display

DISPLAY	STATE	PERFORMANCE in % of $P_{1,max}$
1 flashing green LED	STAND-BY MODE (EXTERNAL CONTROL ONLY)	0
1 green + 1 yellow LEDs	LOW PERFORMANCE	0-25
1 green + 2 yellow LEDs	MEDIUM-LOW PERFORMANCE	25-50
1 green + 3 yellow LEDs	MEDIUM-HIGH PERFORMANCE	50-75
1 green + 4 yellow LEDs	HIGH PERFORMANCE	75-100

When switched on, the pump runs at factory settings or the last setting. The display shows the momentary pump performance.

## Settings display

**WARNING:** LEDs may be turned by 180°, depending on the specific pump type.

By pressing the button the display switches to “performance view” and the current settings will be shown by LEDs for 2 seconds (see figures below).



## Error display

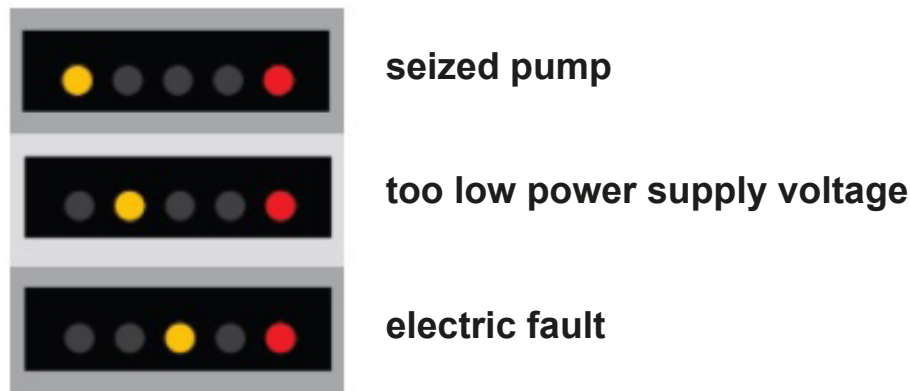

## Setting selection for UPM3

1. Press the pushbutton until the LEDs start flashing, the pump will switch to adjustment selection mode.
2. To select your desired setting, press the button repeatedly until you find the setting you need (see the figures below). If you pass the desired setting, you have to go one more round until it appears again – there is no way back in the loop.



3. Release the button for more than 10 s and the LEDs will return to „performance view“, while the last setting is saved.

## Forbidden pump positions

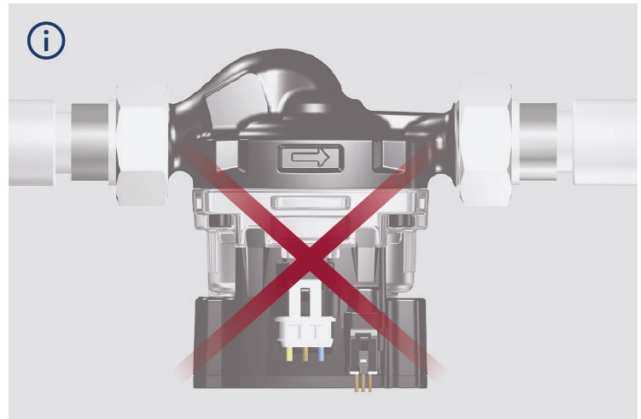
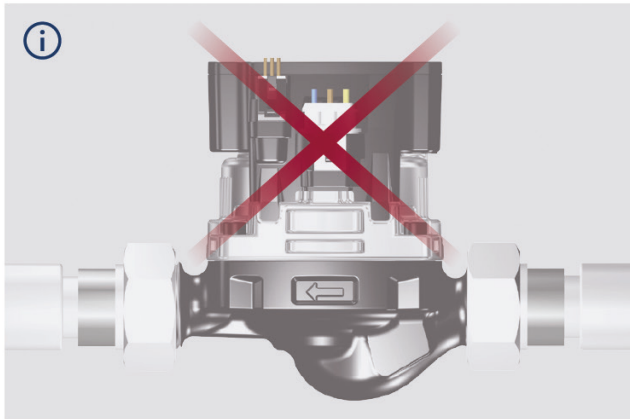

## Permissible pump (actuator) positions

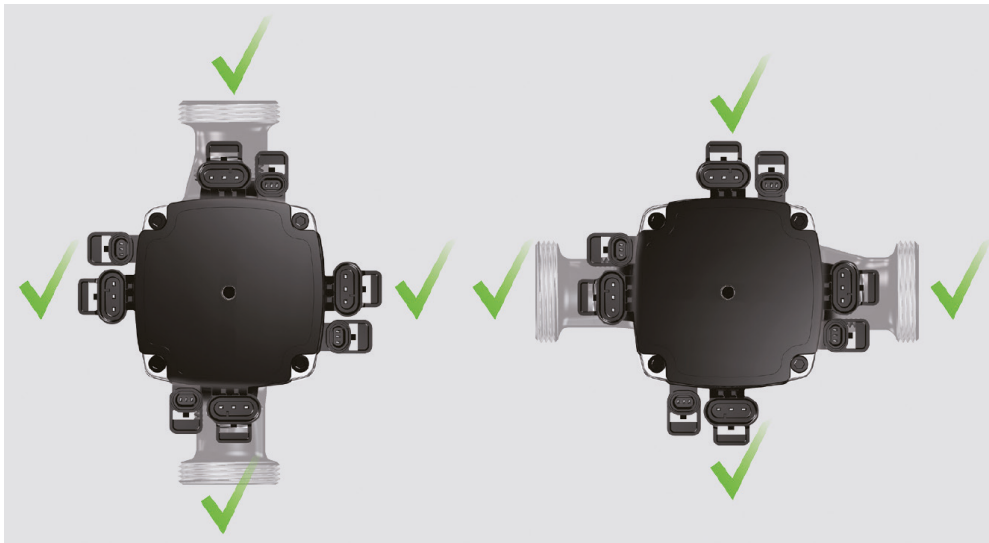

## Pump wiring

