

Owners Manual

RT3-E Regulus Draft Regulator  
**Electric controlled chain operated thermostatic air  
intake regulator for solid fuel fired heat sources**



CE

EN  
verze 1.1

*Regulus*

## Use

Electric controlled chain operated thermostatic air intake regulator for solid fuel fired heat sources.

## Scope of delivery

- RT3-E draft regulator with 3m cable
- hexagonal lever
- chain
- 12V/500mA power adapter

## Technical Data

Control range	30 - 90 °C
Max. water temperature	120 °C
Max. ambient temperature	60 °C
Chain load	100 - 800 g
Working position	horizontal, vertical
Connection thread	outer G 3/4"
Power supply cable length	3 m

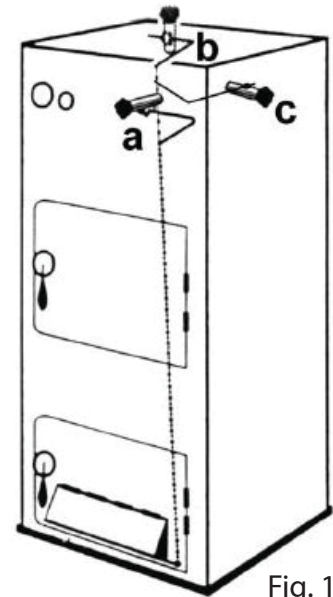

Fig. 1

## Installation

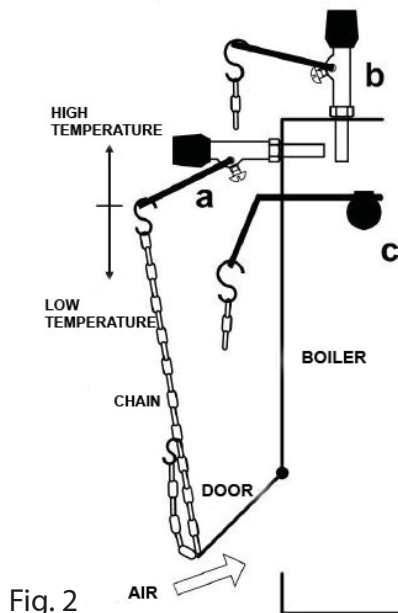

Fig. 2

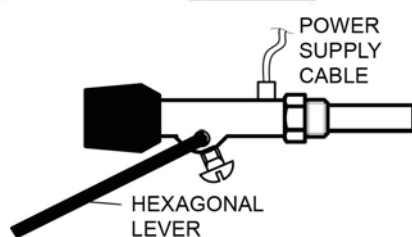

Fig. 3 – outline in detail

Screw the regulator with its G 3/4" outer thread into a sleeve on the boiler with G 3/4" inner thread. Seal the thread (e.g. with Siseal sealant, Teflon tape etc.).

Adjust the regulator in such a way that for horizontal installation (a) the boss to hold the rod points downwards, for vertical installation (b) it points forward and for horizontal side installation (c) upwards, see Fig. 1 and 2. Remove the plastic transport tube and insert a hexagonal lever to its place (the no-hole end). Secure the rod with a screw in such a position that its free, punctured end is above the chain lug on the boiler door and the lever arm is as close to horizontal as possible (as much as the hexagon allows).

Join the chain to the lever using the hole and the bigger hook fixed to the chain. Run the other end of the chain through the fixture on the boiler door and secure the loose end by hooking it on the chain. Check if the chain hangs freely and the lever can move freely (when turning the knob).

When installed in position (a), the white scale is valid for settings (Fig. 2).

When installed in positions (b) and (c), the red scale is valid.

## El. wiring

Only a thermostat equipped with a switch-over contact shall be connected!! RT3-E draft controller shall be wired to an opposite contact than intended for heating. When the set room temperature is reached, the room thermostat opens the heating contact and so the contact wired to RT3-E draft controller gets switched. Electric wiring can be done in two ways, shown in Fig. 4 and 5.

In the first instance (Fig. 4) one of the electric adapter leads is connected to a thermostat input terminal and the other one to the end of one leads of the regulator power supply. The other regulator lead is connected with a thermostat output terminal. The color of wires to be connected between RT3-E and power supply makes no difference, it's freely selectable. The electric adapter is plugged to 230V socket.

In the other instance (Fig. 5) both leads ends of the power supply cable of the regulator are connecter to the lead of the electric adapter, plugged to a 230V socket controlled by a thermostat.

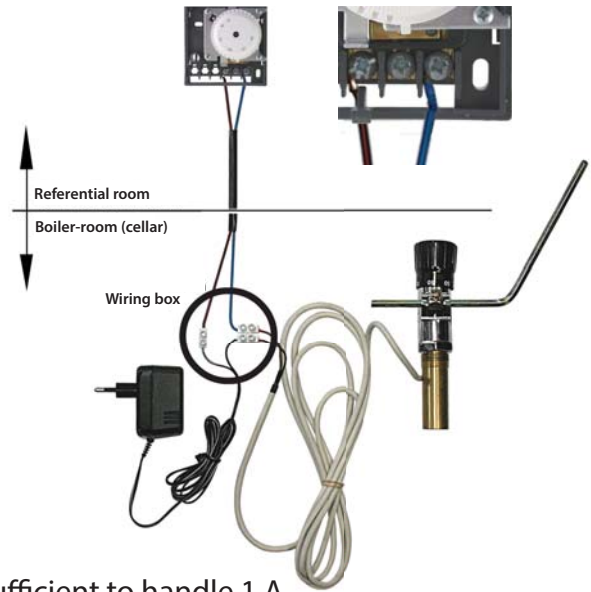
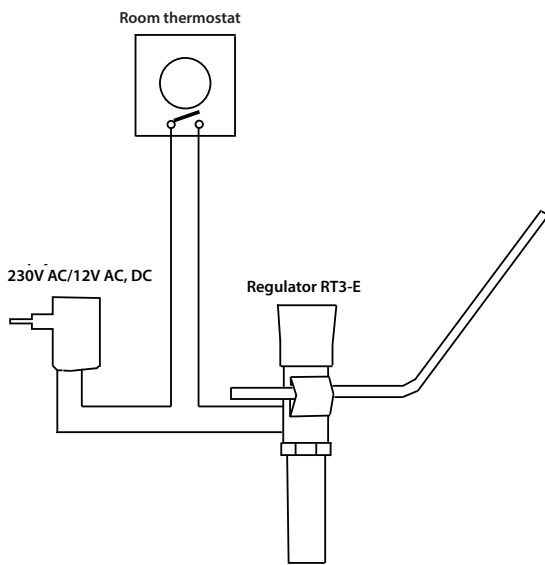

Fig. 4 - a thermostat switches 12V, its contacts shall be sufficient to handle 1 A

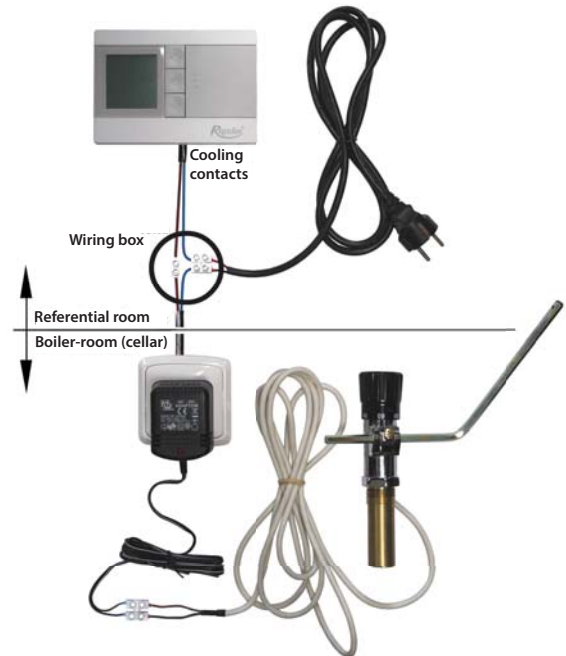
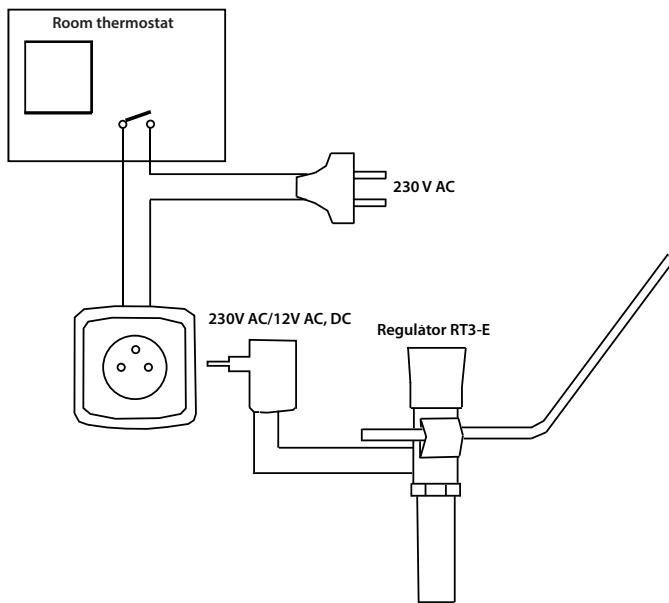

Fig. 5 - a thermostat switches 230V, its contacts shall be sufficient to handle 230 V / 200 mA

### Working principle

When the temperature reaches the set value in the room where the room thermostat is located, the thermostat will switch on. The tension from the power supply flows to the RT3-E Draft controller and it will close the burner door a little. As a consequence, the volume of combustion air will be reduced and the boiler temperature will be decreased. This way also the heating water temperature will fall and subsequently also the room temperature. When the temperature sinks below the set value, the thermostat switches off, the circuit supplying tension to the draft regulator will be interrupted and the regulator will start opening the burner door.

### Regulator calibration

Light up the fire with doors manually open. Set the temperature to 60 using the knob. When water temperature reaches 60°C, wait for a couple minutes to stabilize burning and then adjust the chain for a door gap of 1-2 mm. Now you can set your desired temperature. If the boiler temperature during stabilized operation was lower than set, shorten the chain, in the opposite situation the chain should be extended. Before performing calibration, check if the boiler is working under optimum conditions, i.e. a position of the secondary air damper, boiler and heating system inertia, the quantity of fuel and ashes in the boiler. These factors may influence the boiler temperature disregarded of the regulator.

# WARRANTY CERTIFICATE

*for Regulus RT3-E Draft Regulator*

## WARRANTY CONDITIONS

1. The warranty period is 24 months from the date of purchase either of the regulator or of a boiler, if the product was supplied with a boiler.
2. When claiming warranty, this Warranty Card must be submitted together with the purchase receipt.
3. The warranty is valid only when the technical conditions set by the Manufacturer, installation manual and instructions in the documentation and on the product itself are maintained.
4. The warranty does not cover defects caused by external conditions or improper operation conditions, defects caused by usual wear and tear, further when the product is not used in compliance with its purpose and when the defect was caused by:
  - mechanical damage to the product or its part
  - improper handling
  - tampering by a third person
  - improper installation
  - improper stocking
  - natural disaster

**Date of Purchase:**.....

**Rubber stamp print and signature of the seller:**

01/2016

The logo for Regulus, featuring the word "Regulus" in a stylized, red, italicized font with a red swoosh underneath.

**REGULUS spol. s r.o.**  
Do Koutů 1897/3  
143 00 Praha 4

<http://www.regulus.eu>  
E-mail: [sales@regulus.eu](mailto:sales@regulus.eu)