

Regulus

www.regulus.eu



RegulusHBOX

Installation and Operation Manual
RegulusHBOX 212 RTC 3/1

EN

RegulusHBOX

CONTENTS

A. GENERAL INFORMATION	5
A1. Safety Instructions	5
A2. Application, Description	5
A3. Components	7
A4. Internal Hydraulic Connection	8
A5. Parameters	9
B. INSTALLATION, CONNECTION	11
B1. Dimensions	11
B2. Installation Site Requirements	12
B3. Installation	13
B4. Hydraulic Connection	13
B4.1. Hydraulic Variant with one heating circuit	15
B4.2. Hydraulic Variant with two heating circuits	16
B5. Electrical Wiring	17
B5.1. Cable Entry	17
B5.2. Terminal Block	18
B5.3. Complete Inner Wiring Diagram	19
B5.4. Wiring Diagram of M&R Peripherals to RegulusHBOX	20
B5.5. Connection and Adjustment of Optional Accessories - room sensor/unit, thermostat...	21
B6. Pre-commissioning Inspection	22
C. SETTINGS USING THE MAIN DISPLAY	23
C1. Main menu	23
C1.1. Settings for HEATING	24
C1.2. Settings for HOT WATER	24
C1.3. Settings for DHW RECIRCULATION	25
C1.4. Other settings	25
D. HOW TO SET ACCESS TO CONTROLLER WEBSITE	26
D1. How to connect the controller to a local network	26
D2. How to connect the controller to a PC directly	27
D3. How to connect via IR Client mobile application	28
E. SETTING THE CONTROLLER THROUGH WEB BROWSER	29
E1. Home Screen (HOME)	29
E2. Tiles for Heating and Hot Water	30
E3. Tiles for Hot Water Recirculation and Ventilation	30
E4. Display of the Diagram (DIAGRAM)	31
E5. Heating Zone Menu (HEATING)	31
E6. Heating Zone Settings (Zone 1 to 6)	32
E6.1. Room Temperature Settings	32
E6.2. Time Program Settings	32
E6.3. Summer/Winter Function Settings	33

E6.4. Weather Compensating Heating Curve Settings	33
E7. AKU Zone	35
E8. Pool Heating	35
E9. Holidays	35
E10. DHW Menu (HOT WATER)	36
E10.1. Hot Water Heating by Heat Pump	36
E10.2. Hot Water Heating by Auxiliary Source	36
E11. Hot Water Recirculation Settings	37
E12. Sources Menu (SOURCES)	37
E12.1. Heat Pump	37
E12.2. Solar Heating	38
E12.3. Fireplace, Solid Fuel Boiler	38
E12.4. RegulusHBOX Electric Heating Elements	39
E13. Other Settings Menu (OTHER)	39
E13.1. Inputs and Outputs	39
E13.2. Access and Password	39
E13.3. General Settings	39
E13.4. E-mail Notifications	39
E13.5. Function Overview	39
E13.6. Fault history	39
E13.7. HRV Zone	39
E13.8. Universal Outputs	41
E13.9. RegulusRoute	41
E14. Manual Access Menu (MANUALS)	41
F. ADJUSTING THE CONTROLLER THROUGH THE SERVICE DISPLAY	42
F1. Controller Input	42
F2. Overview of Parameters Displayed on the Service Display	42
F2.1. Basic Display	42
F2.2. Zone Display (zone 1, zone 2)	43
F2.3. Solar Thermal System Display	44
F2.4. Display of Hot Water Zone Heated by Auxiliary Source (DHW-E)	44
F2.5. Display of Hot Water Zone Heated by Heat Pump (DHW)	44
F2.6. Display of Heat Pump, Heat Pump Cascade (HP in series)	45
F2.7. Display with Firmware Version and Release Date	46
F2.8. Controller in Factory Settings	46
F2.9. Select the Desired Setting (menu)	46
F3. User Settings	47
F3.1. Heating Zones	47
F3.2. HRV Zone	47
F3.3. Time Programs	48
F3.4. Weather Compensating Heating Curves	48
F3.5. Heat Pump Control	48
F3.6. HP Faults	48
F3.7. Other Faults	48

F3.8. Settings of DHW Heating by the Heat Pump (DHW-HP)	49
F3.9. Settings of DHW Heating by Auxiliary Source (DHW-E)	49
F3.10. Settings of Thermal Store Heating	49
F3.11. Settings of DHW Recirculation	49
F3.12. Statistics	49
F3.13. Operating Data	50
F3.14. Other	50
F3.15. Date and Time Settings	50
F3.16. RegulusRoute - Service Connection Parameters	50
F4. Add-on Modules	51
F4.1. Fire Module	51
F4.2. UNI Module, UNI Module 2	51
G. MAINTENANCE	52
G1. Maintenance by the User	52
G2. Removing the Front Covers	52
G3. Removing the Wiring Cover	53
G4. Professional Maintenance	53
G5. Discontinuing Operation	54
G6. Recycling / Disposal	54
H. SERVICING	54
H1. Fault Indication	54
H2. Record of Repairs and Inspections	55

A. GENERAL INFORMATION

This Installation and Operation Manual forms an integral part of the product. Before starting any work, read this manual and keep it accessible at all times. Should you lose the manual, you can download the current version in pdf format from the website **www.regulus.eu**.

A1. Safety Instructions

- **This appliance should only be used by persons who have been properly instructed in the safe use of the appliance and understand the risks involved. The appliance should not be used by children and persons with limited physical, sensory or mental abilities or with insufficient experience and knowledge. It is expressly forbidden for children to play with the appliance!**
- **The hydraulic connection** of RegulushBOX shall be carried out by a professionally qualified person in compliance with the applicable standards and regulations.
- **Only persons with electrical qualification are permitted to remove the wiring cover.**
- All electrical installation work must be carried out by a professionally qualified person, in accordance with this Manual and in compliance with the applicable standards and regulations.
- Do not tamper with the internal wiring of RegulushBOX, it is complete from the production.
- **Before starting work on the electrical installation, it is necessary to disconnect RegulushBOX from the power supply!**
- **The controller integrated in RegulushBOX in no way replaces the safety elements of the heating system or the hot water system.** These safety elements must be installed in accordance with the applicable standards and regulations. Carry out the installation according to the design and make sure all prescribed safety elements are installed.
- The setting of the controller and the connection of optional accessories must be carried out in accordance with the instructions given in this manual.

A2. Application, Description

RegulushBOX indoor unit is intended for space and DHW heating with a RTC single-phase inverter heat pump.

The unit involves a combination thermal store (HSK type). DHW is heated continuously in a stainless-steel heat exchanger. The tank is intended for heating systems with one or multiple mixed or unmixed heating circuits. A solar thermal system can be connected through an optional solar module (kit with a heat exchanger).

The operation of RegulusHBOX and connected heating and hot water systems is controlled by a built-in smart controller which comes completely electrically wired from the factory. This controller is equipped with its own website (web server) permitting remote control through a web browser or from a smartphone or tablet with the application Regulus IR client installed (versions for Android and iOS are available).

RegulusHBOX involves a HSK combination thermal store with an integrated stainless-steel heat exchanger for DHW heating, fitted with 2 heating elements of 12 kW total output, switched in 2 kW steps.

Heat pump switching between the heating system and DHW heating is ensured by a three-way zone valve with actuator.

Information on the current operating status can be read on the control unit with a graphical display located on the front cover of RegulusHBOX. **The connecting cable of the control unit is not connected (to avoid being unintentionally torn out during installation).** It needs to be connected to its counterpart marked "Display" on the wiring compartment cover during installation. If necessary, the control unit can be moved to the living area of the house where it can also act as a room temperature and humidity sensor (using JYSTY 1x2x0.8 cable). In this case, a blanking plug shall be installed instead of the control unit (code 18248 - not included in supply).

Basic elements of RegulusHBOX indoor unit

- IR RegulusHBOX Controller with remote access from a computer or a mobile app.
- Control unit with graphical display, English menu, that can be used as a room unit (two-wire connection).
- HSK combination thermal store of 210 l total volume, divided by a tight separating partition in the ratio 49 l (heating), 140 l (DHW heating), 21 l (stainless-steel heat exchanger).
- DHW heating in a stainless-steel heat exchanger, 6 sqm.
- 12 kW heating elements, switched in 2 kW steps (max. output can be limited in the controller menu).
- Three-way zone ball valve for heat pump switching between space and DHW heating.
- 12 l expansion vessel for heating system.
- Waste pipe from safety valves incl. stench trap.
- Electric wiring incl. terminal block for easy connection of a heat pump and other accessories incl. basic element protection.
- Heating water temperature and pressure sensor, DHW temperature sensor.

Accessories enclosed in the package

- Heating system safety group incl. air vent valve, 3 bar safety valve, pressure gauge and T-piece for topping up heating water / connecting a supplementary expansion vessel for case when the integrated 12 l expansion vessel is not sufficient.
- Safety kit for a cold water pipe incl. check valve, 8 bar safety valve, pressure gauge, T-piece for connecting an expansion vessel/recirculation and T-piece for topping up heating water.
- Outdoor temperature sensor.
- Pump station for heat pump circuit with Wilo Para 25/8 iPWM1 circulation pump.
- 2l DHW expansion vessel.

A3. Components

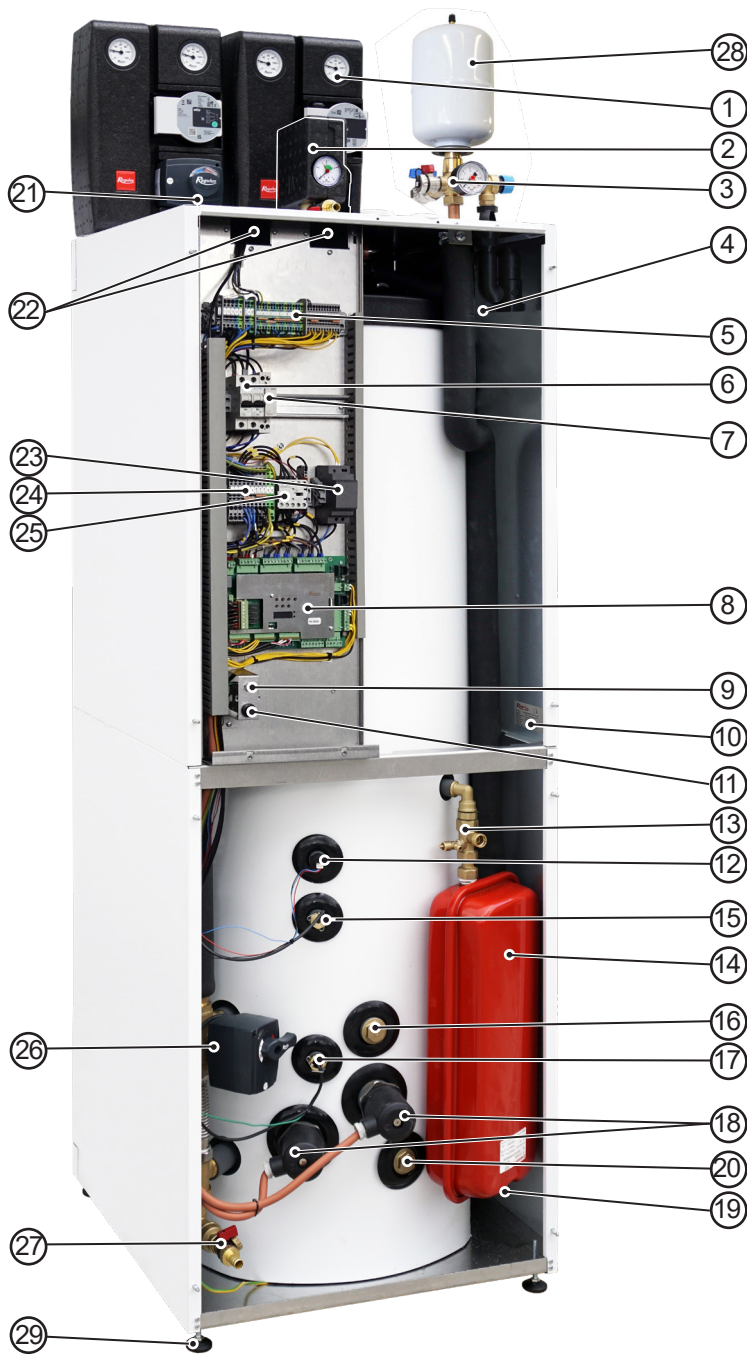

The photo of the open RegulusHBOX shows its state with the wiring cover removed.

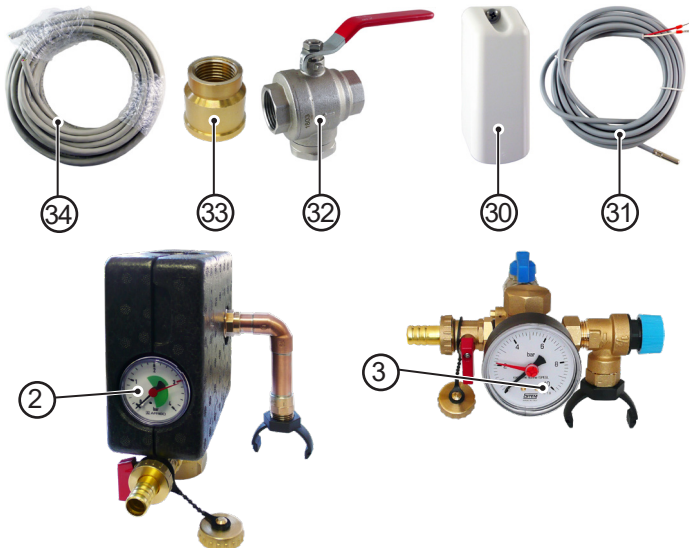

- 1 – Pump station of the heat pump circuit - included in supply
- 2 – Heating system safety group (3bar safety valve, air vent valve, pressure gauge, T-piece with a drain valve designed for heating system topping up) - included in supply
- 3 – Cold water safety kit (G3/4“F shutoff valve for connecting cold water supply, check valve with service valve, cold water safety valve 8 bar, drain valve used also for topping up the heating system, pressure gauge, T-piece for connecting DHW recirculation / expansion vessel) - included in supply
- 4 – P-trap w. stench trap
- 5 – Terminal block
- 6 – Circuit breaker for measurements & control (B6A 1p) and heat pump circuit breaker (B20A 1p)
- 7 – Heat pump contactor
- 8 – IR RegulusHBOX controller
- 9 – Control unit connector
- 10 – Label w. serial number
- 11 – Safety thermostat
- 12 – Pressure sensor for pressure monitoring in heating system
- 13 – Expansion vessel service valve
- 14 – 12l heating system expansion vessel
- 15 – DHW control sensor
- 16 – Inlet for solar module
- 17 – Safety thermostat sensor
- 18 – 2x6 kW electric heating elements
- 19 – Expansion vessel valve
- 20 – Outlet for solar module
- 21 – Heating system pump station (not included in supply)
- 22 – Cable glands
- 23 – Power supply for IR
- 24 – Auxiliary internal terminal block
- 25 – Contactor for electric heating elements
- 26 – Three-way zone valve for switching between space and DHW heating
- 27 – G1/2“M drain valve of heating system and thermal store
- 28 – 2l DHW expansion vessel - included in supply
- 29 – Adjustable feet for levelling RegulusHBOX
- 30 – Pt1000 outdoor temperature sensor - included in supply
- 31 – Pt1000 temperature sensor for heating water, w. 4m long cable - connected, placed in cable gland
- 32 – Ball valve with filter and magnet (marked MFB in the hydraulic connection diagram) - included in supply
- 33 – 3/4“F x 1/2“F reducing adapter for DHW expansion vessel
- 34 – Communication cable

A4. Internal Hydraulic Connection

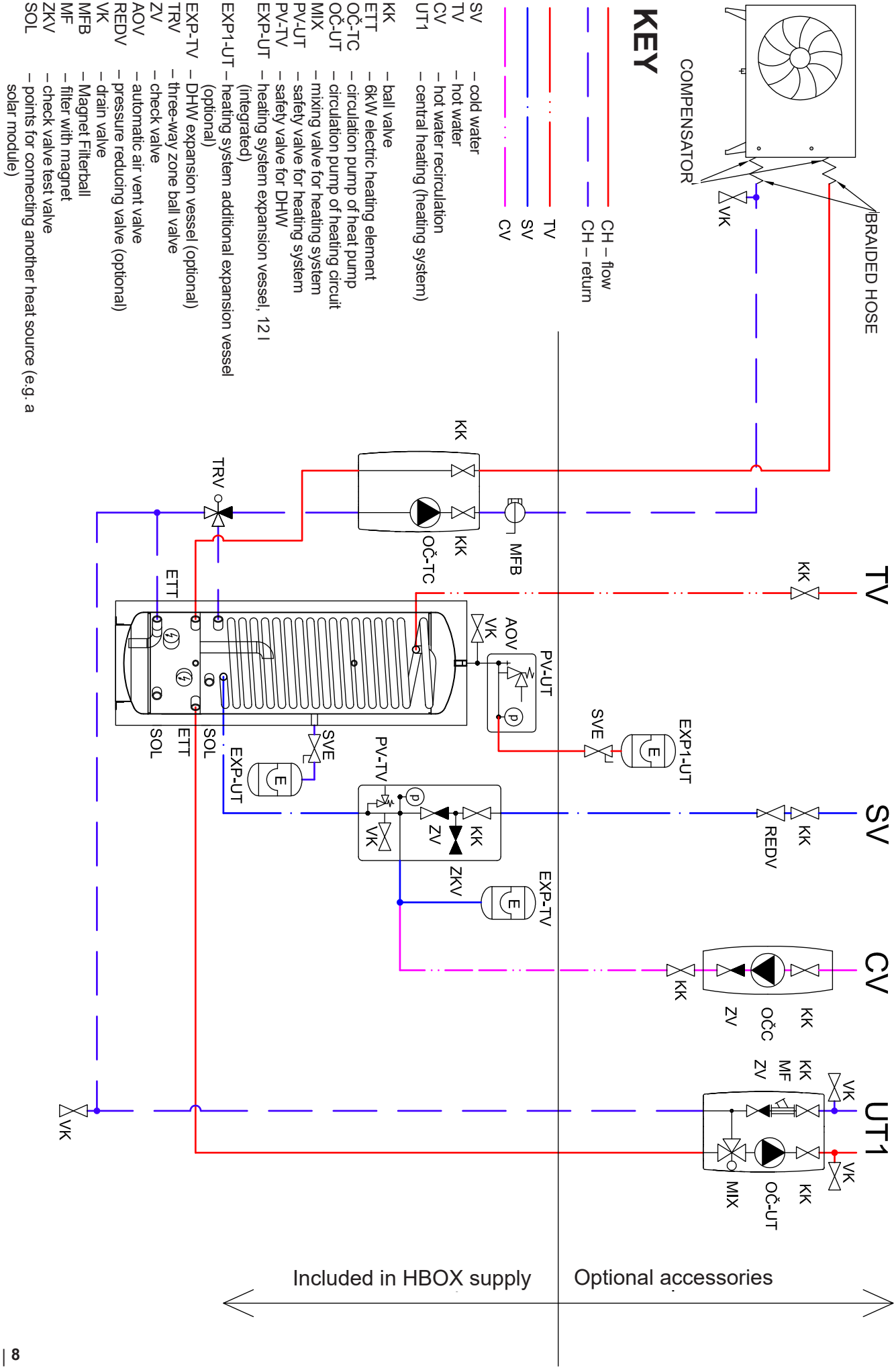

A5. Parameters

Technical Data	
Total tank volume	210 l
Total fluid volume in tank	189 l
Fluid volume above the separating metal sheet	140 l
Fluid volume below the separating metal sheet	49 l
Fluid volume in DHW heat exchanger	21 l
DHW heat exchanger surface area	6 m ²
Fluid working temperature	5–90 °C
Max. working pressure – heating system	3 bar
Min. working pressure – heating system	0.5 bar
Max. working pressure – DHW	8 bar
Ambient temperature	5–40 °C
Max. relative humidity	80 %, non condensing
Safety valve set pressure – heating system	3 bar
Safety valve set pressure – DHW	8 bar
Safety valves seat cross section	132 mm ²
Safety valve discharge coefficient	0.3
3-way valve actuator run time	15 s
Heat loss	160 W
Total weight without water	148 kg
Total weight with water	360 kg
Overall dimensions (W x H x D)	595 x 1725 x 650 mm
Tipping height (without pump stations and safety groups connected)	1790 mm

Electric Data	
Power supply	3/N/PE ~ 400 / 230 V 50 Hz
Max. cross section of power cable	4 mm ² (stranded wire) / 6 mm ² (solid core)
Nominal power input	12.2 kW (without a heat pump connected)
Heating elements	2 x 6 kW (3 x 2 kW – each 230 V)
IP rating	IP20
Circuit breaker for heat pump	B20A 1p
Circuit breaker for measurement and control	B6A 1p

Pressure Drop Diagram - heating

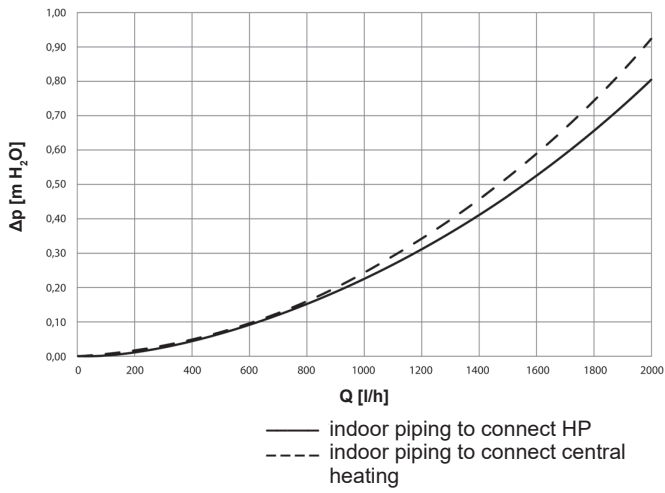

Pressure Drop Diagram - DHW

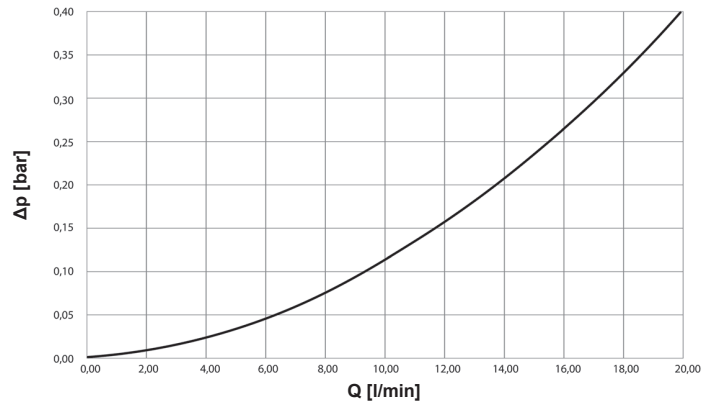

Wilo Para 25/8 iPWM1 pump performance curves

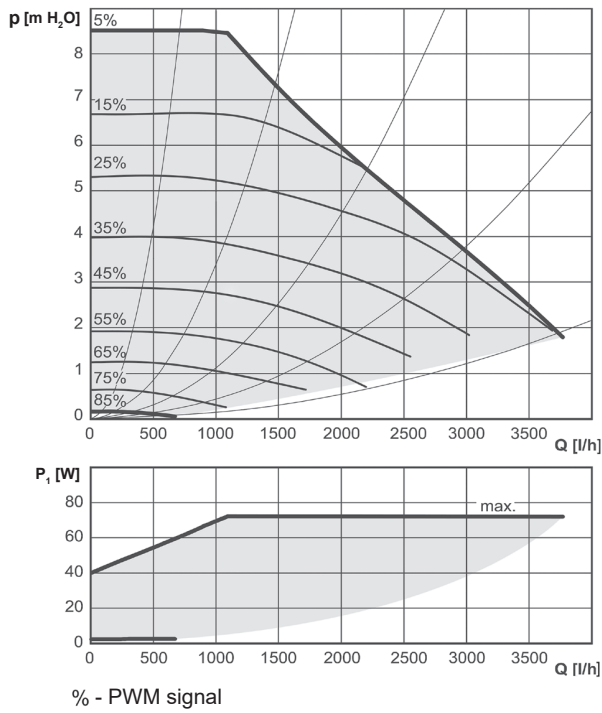

B. INSTALLATION, CONNECTION

B1. Dimensions

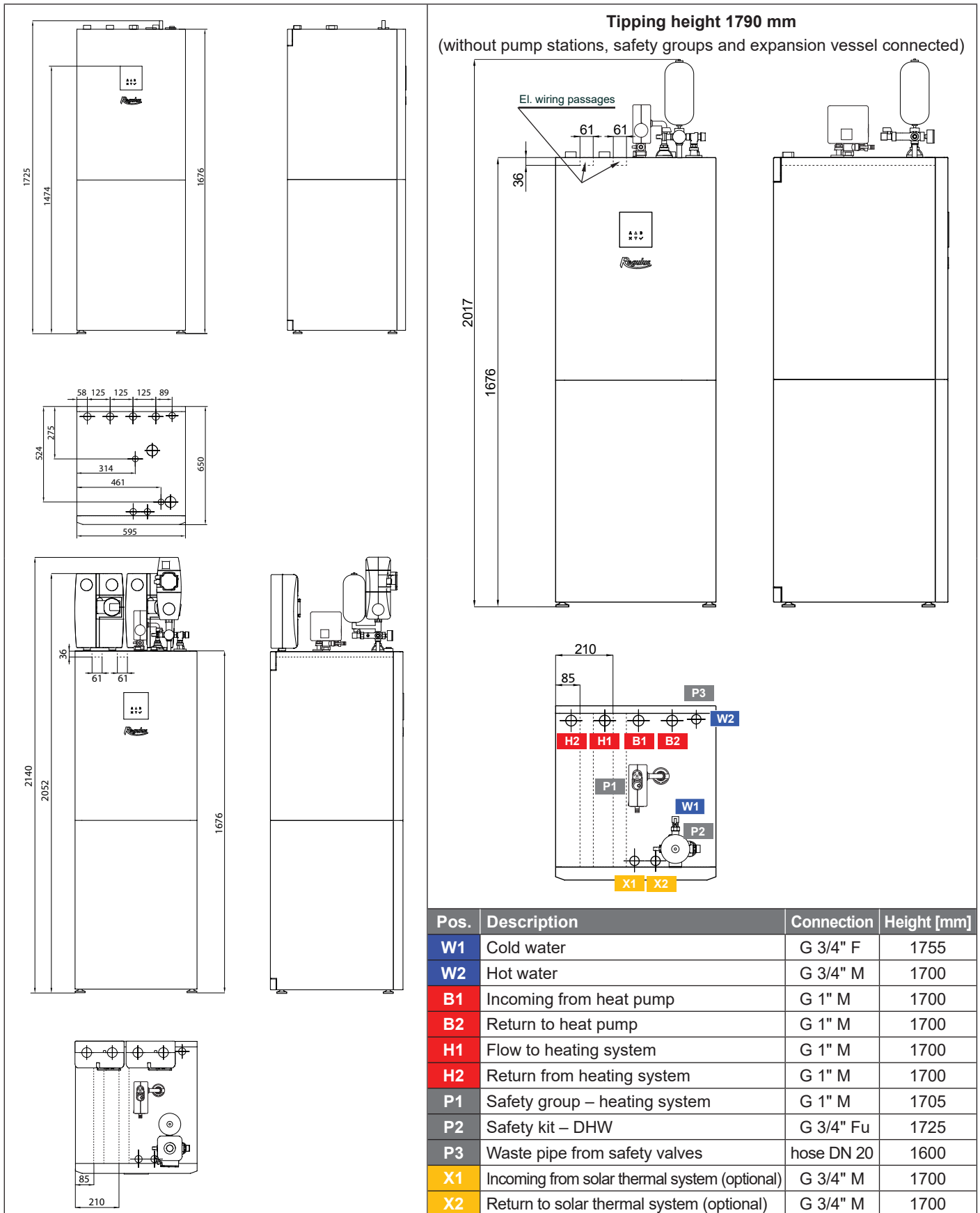

B2. Installation Site Requirements

- RegulusHBOX shall be installed indoors only.
- Ensure that no water can enter RegulusHBOX at the installation site.
- Do not install the device in areas with a bath or shower in zones 0, 1 and 2.
- Do not install RegulusHBOX at places with a risk of freezing.
- Do not install the device near aggressive, explosive or flammable gases, objects or substances.
- Observe the minimum required clearances from the constructions according to the picture - RegulusHBOX is designed to be installed also in a narrow space.

Installation with pump stations

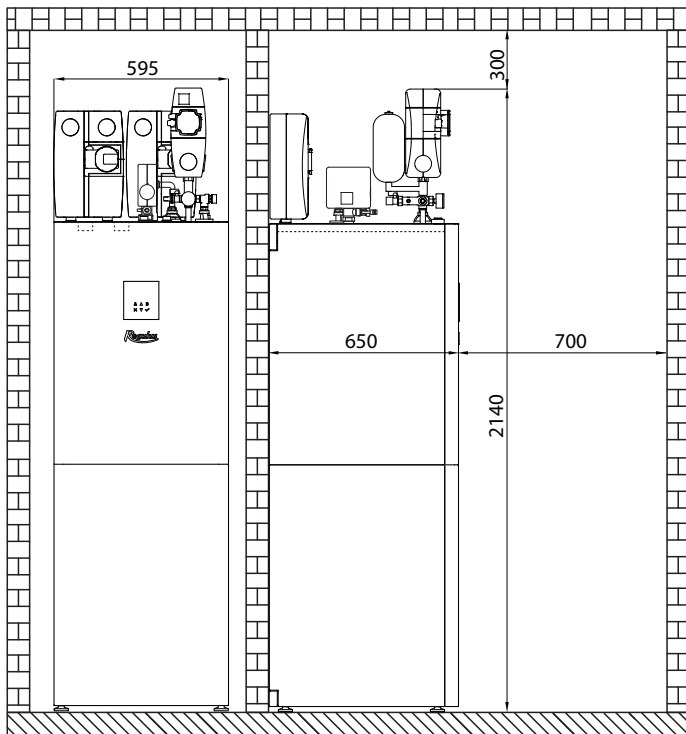

Installation without pump stations and expansion vessel (low ceiling)

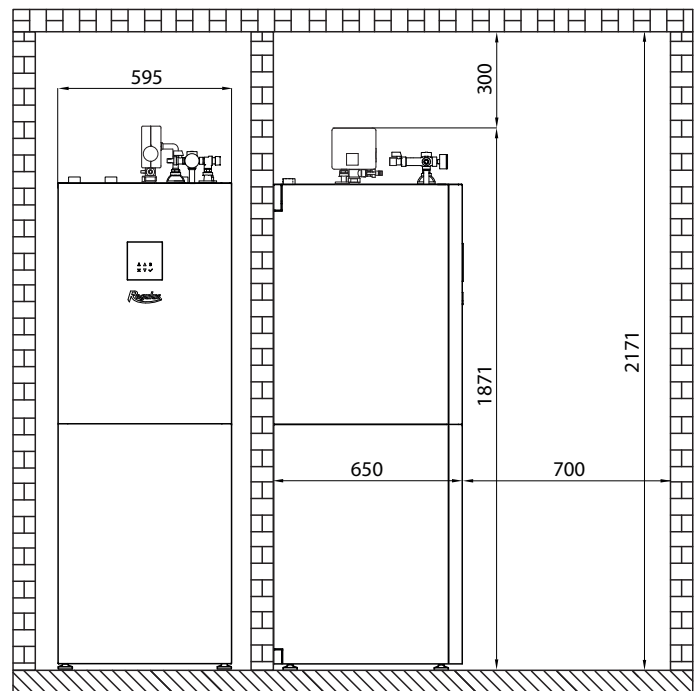

B3. Installation

Transport RegulusHBOX to the installation site in a vertical position. **It is not permitted to transport RegulusHBOX in a horizontal position.**







Install RegulusHBOX on a level floor with sufficient floor loading capacity - the weight of RegulusHBOX without heating water is 148 kg, with water it is 360 kg.

Level RegulusHBOX vertically using its adjustable feet.



B4. Hydraulic Connection

A. *The pipe connection outlets are marked with the respective pictograms on the upper side of RegulushBOX.*

- 1** - G 1" M return from heating system 
- 2** - G 1" M flow to heating system 
- 3** - G 1" M incoming from heat pump 
- 4** - G 1" M return to heat pump 
- 5** - G 3/4" M hot water 
- 6** - G 1" M heating system safety group 
- 7** - G 3/4" F cold water safety cold water connection 
- 8** - Waste pipe from safety valves, DN 20 hose (from the rear)
- 9** - Passages for connecting an optional solar module

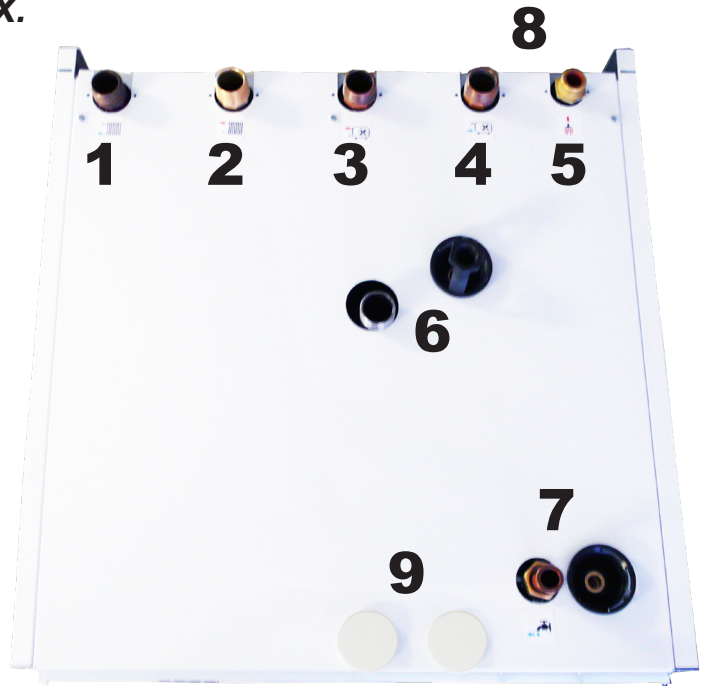

B. Installation of the enclosed accessories:

1 - mount the pump station with the circulation pump of the heat pump circuit on connections 3 and 4 (G1"M). Install a ball valve with filter and magnet (marked MFB on the hydraulic connection diagram) in an easily accessible place of the return pipe to the heat pump. The pump station includes a Wilo Para 25/8 iPWM1 circulation pump, two ball valves and two thermometers. Cables with a connector for power supply and control of the circulation pump are factory-connected to the main terminal block. To connect the circulation pump, it is enough to remove the cables from the cable passage where they are stored and connect the connectors to the pump.



2 - mount the safety group of the heating system with the T-piece and G 1/2" valve on the connection 6 (G 1" M), connect the waste from the safety valve to the drain tundish located in the cover of RegulushBOX. The safety group involves a safety valve, air vent valve and pressure gauge. The G 1/2" valve is intended for topping up the heating system.

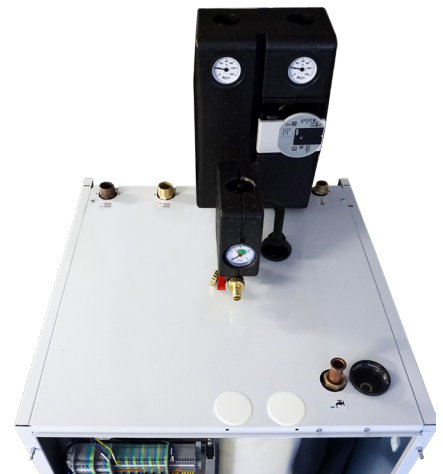

3 - mount the cold water safety kit on the pipe 7 (Cu 18 mm with G 3/4" union nut), connect the waste from the safety valve to the drain tundish located in the cover of RegulushBOX. The safety kit involves a shut-off valve, check valve with service valve, safety valve, pressure gauge and G 1/2" drain valve that is intended also for topping up the heating system.



Cold water from the mains

4 - mount the G 3/4" to G 1/2" reducing adapter onto the safety group; mount the expansion vessel to the adapter.
 - When installed in low ceiling rooms, the expansion vessel can be placed outside HBOX and connected through the appropriate piping.

- When installing the optional DHW recirculation pump station, follow the respective Instruction Manual. The pump station incl. its installation kit has code 20276.



G 3/4" to G1/2" reducing adapter



C. Connection to system

Connect RegulushBOX to the system according to the hydraulic connection diagram:

- 1 - Connect the pump station of the heating system or the manifold in the case of connecting several heating circuits to connections 1 and 2 (G 1"M). A heating water temperature sensor is connected to terminal A/DI14 of the motherboard; it is stored in the cable passage. Place this sensor in the sheath in the pump station or in the flow pipe to the heating system.
- 2 - connect the cold water supply to the G 3/4"F port of the ball valve in the cold water safety kit
- 3 - connect the hot water outlet to the connection 5 (G 3/4"M)
- 4 - connect the waste pipe to hose 8 (DN20). The waste pipe from the safety valves is equipped with a stench trap from the factory.
- 5 - if the system includes DHW recirculation piping, connect the piping to the DHW recirculation pump station - for its installation see the instructions above.
- 6 - if the 12 l built-in expansion vessel is not sufficient, connect an additional expansion vessel of the heating system - remove the drain valve under the safety group, add a T-piece, connect the pipe to the expansion vessel and re-install the drain valve.
- 7 - for filling the system, switch the actuator of the 3-way zone valve (marked TRV in the connection diagram) to manual mode and set the control lever to 45°. After filling and air bleeding the heating system switch the actuator back to automatic mode.

B4.1 Hydraulic Variant with one heating circuit

KEY

- 1 – Regulius heat pump (RTC, CTC)
- 2 – HBOX indoor unit (RTC, CTC)
- 3 – additional heating system expansion vessel (optional – integrated 121 one is included)
- 4 – DHW expansion vessel
- 5 – safety kit for combination thermal store (included in HBOX supply)
- 6 – pump station for DHW recirculation – CSE TV ZV (optional)
- 7 – safety group for heating system (included in HBOX supply)
- 8 – pump station for heat pump (included in HBOX supply)
- 9 – pump station for heating system (not included in supply – needs to be chosen)

- SV – cold water
- TV – hot water
- CV – hot water recirculation
- ÚT – central heating (heating system)
- KK – ball valve
- ZV – check valve
- AOV – automatic air vent valve
- REDV – pressure reducing valve (optional)
- VK – drain valve
- SVE – expansion vessel service valve
- PV-ÚT – safety valve for heating system
- MFB – Magnet Filterball

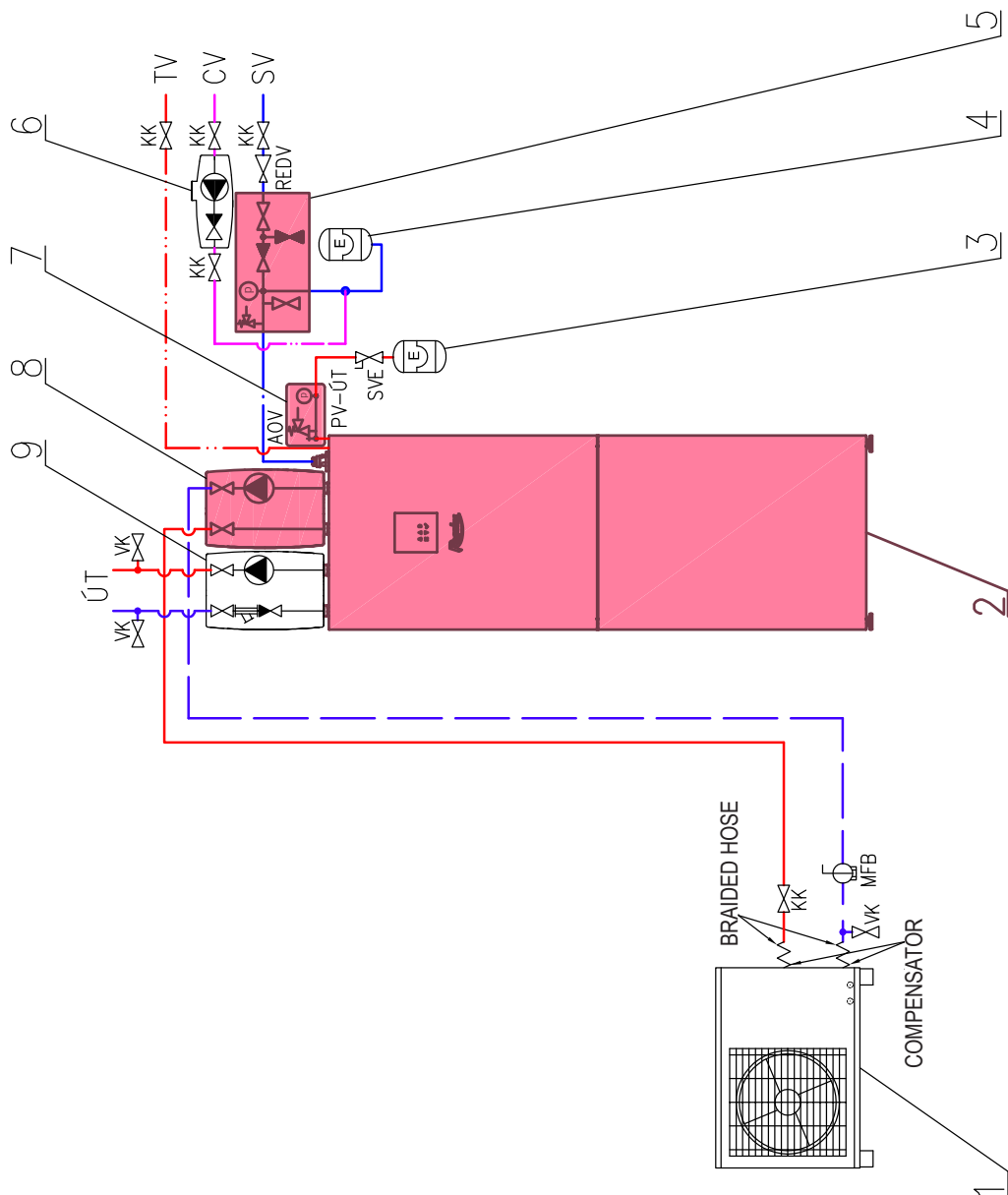

B4.2 Hydraulic Variant with two heating circuits

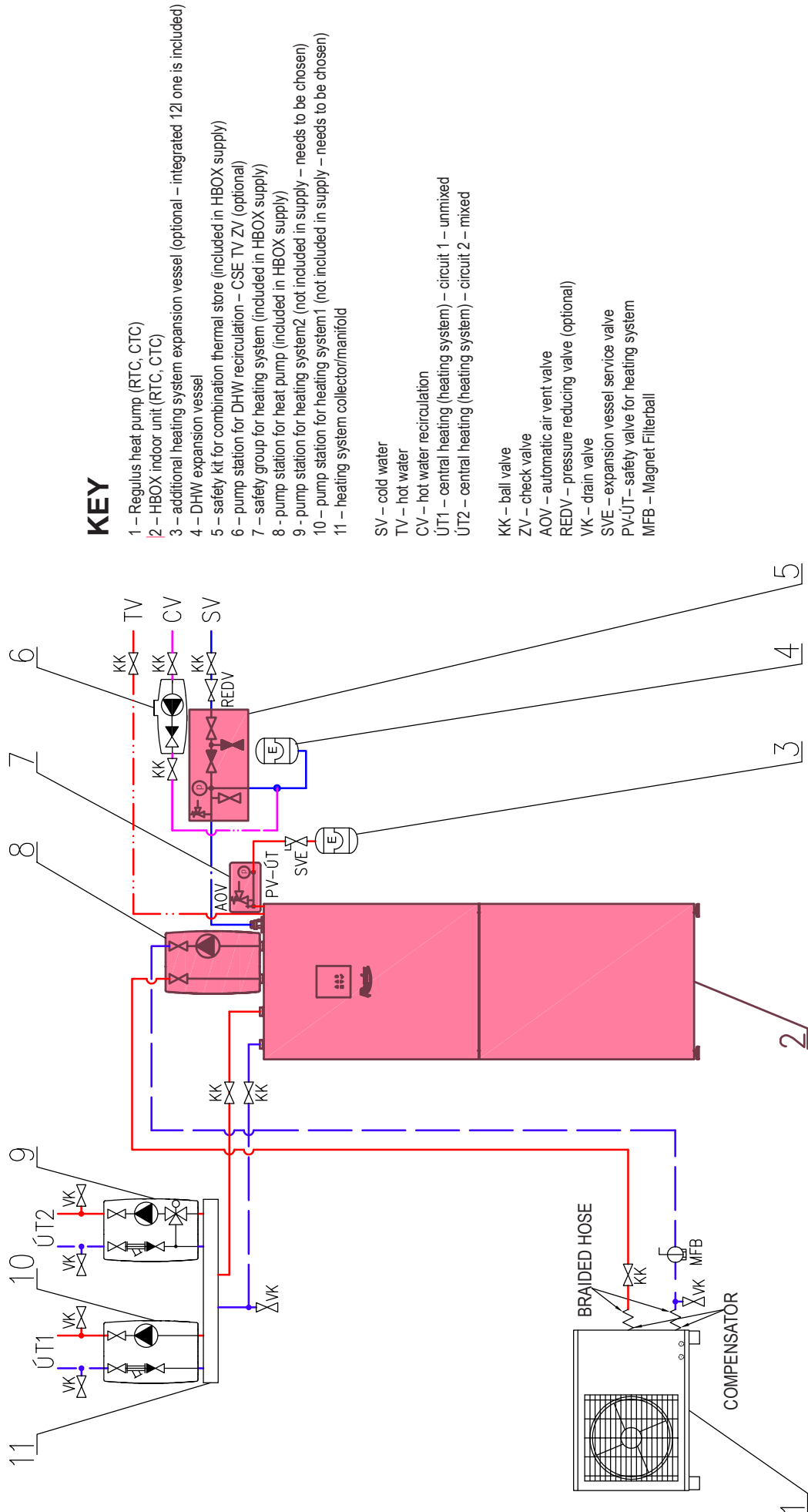

B5. Electrical Wiring

B5.1. Cable Entry

For the electrical connection of the RegulushBOX, it is necessary to remove the upper front cover and the wiring cover located below it.

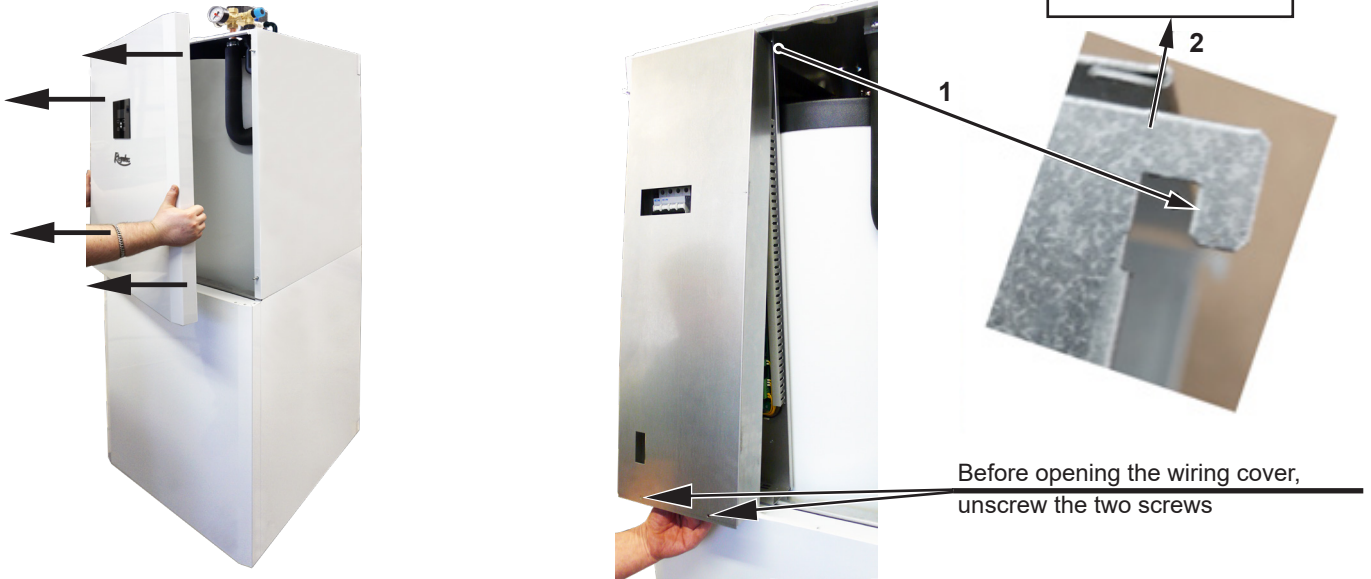

Two passages under the lid of the RegulushBOX are used to connect cables

Note: The power supply cable is used not only to supply RegulushBOX, but also to supply the heat pump! Under normal conditions, it is recommended to prefer the cross-section of the copper conductors of the power supply cable 4 mm².



We do not recommend the use of wire ferrules when connecting the maximum cross-section of the stranded wire to the connection terminal block. Wire ferrules are suitable for wires with a smaller cross-section (typically sensors, PWM, etc.). Minimum stripping length 9 mm.

After closing the wiring cover, it is necessary to connect the control unit connector before refitting the top cover.

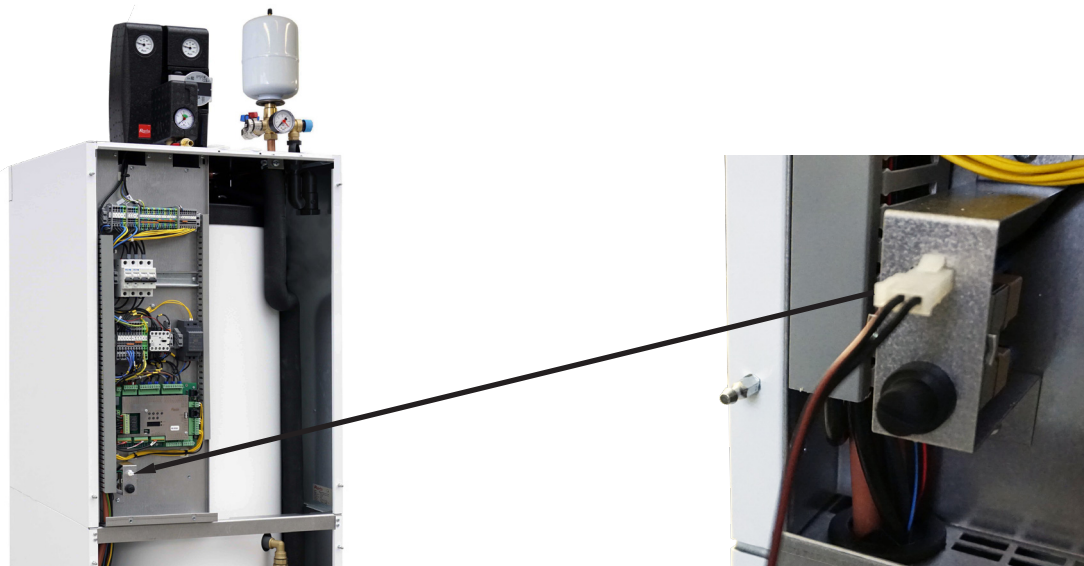

B5.2. Terminal Block

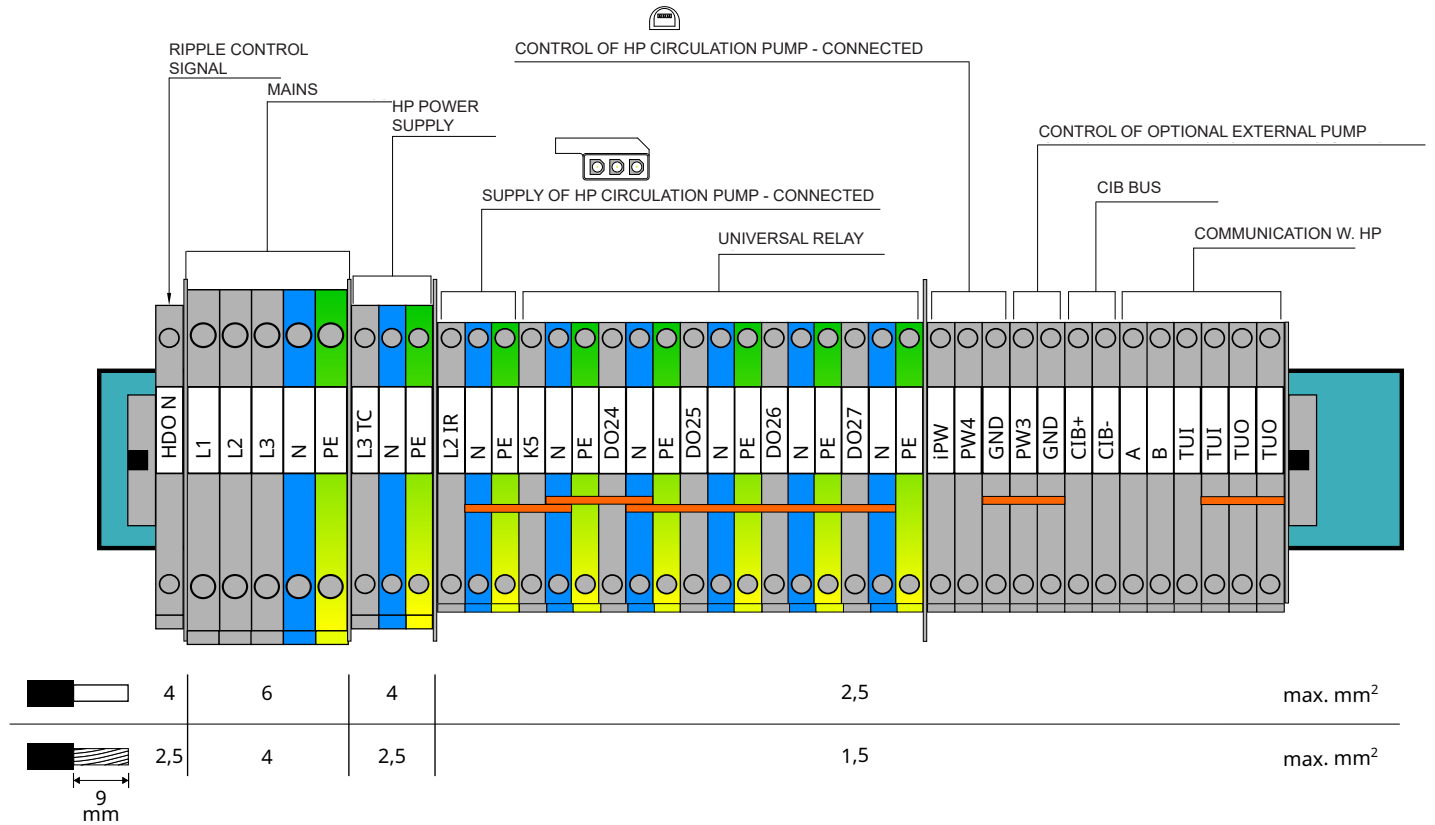

Universal outputs K5 and DO24-DO27 have no default function. The devices switched from these outputs need to be set on the service level of the controller.

B5.3. Complete Inner Wiring Diagram

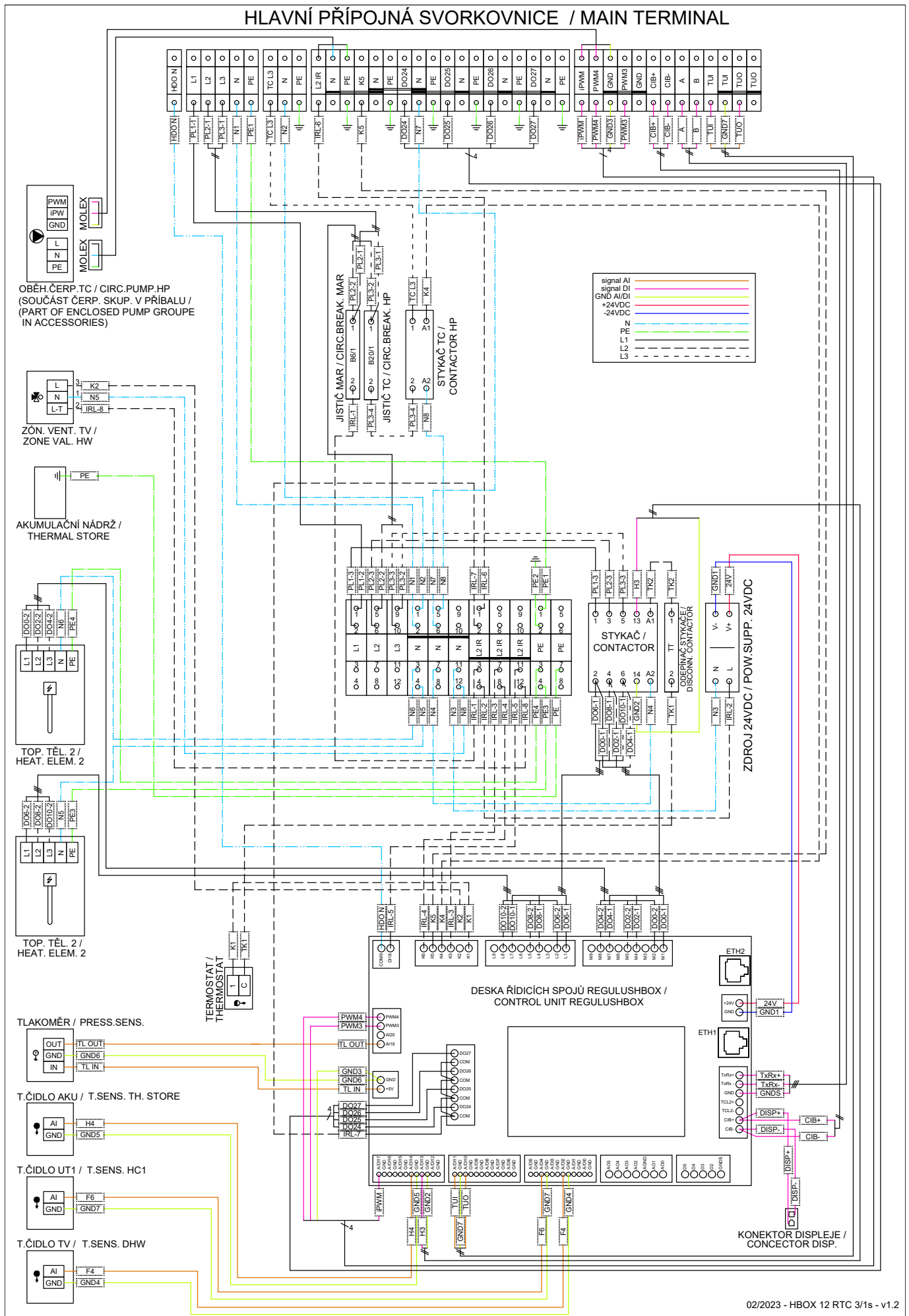

B5.4. Wiring Diagram of M&R Peripherals to RegulushBOX

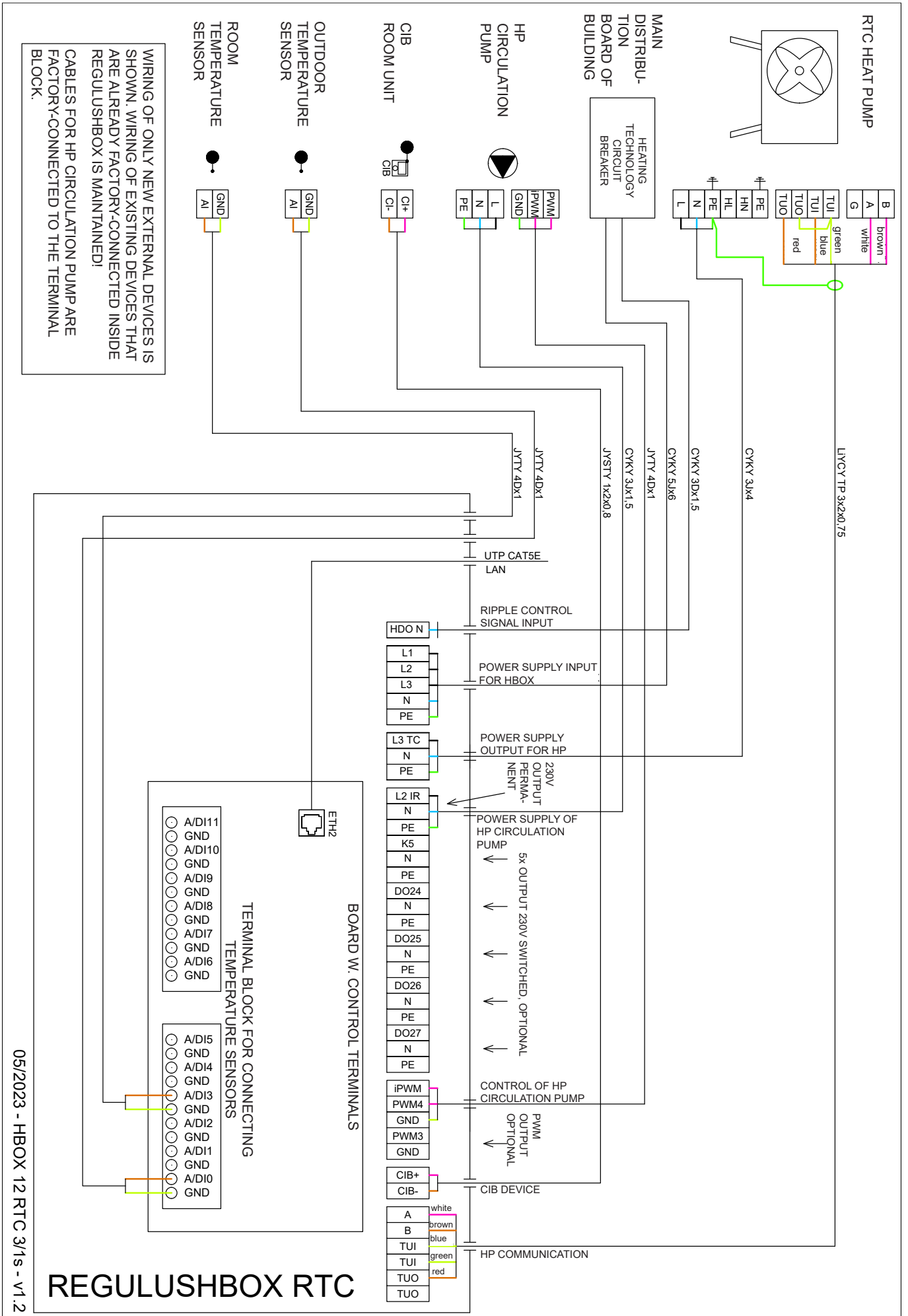

05/2023 - HBOX 12 RTC 3/1s - V1.2

B5.5. Connection and Adjustment of Optional Accessories - room sensor/unit, thermostat

In each heating zone, it is possible to measure the room temperature using one of the following elements:

- Pt1000 room sensor
- RC25 room unit
- RCA room unit (buil-in display that is included in supply)
- WiFi RSW 30 Wireless room sensor
- current room thermostat with NO or NC contacts

Assign the type of room sensor (unit) installed to the appropriate zone in the service menu of the controller.

The web interface of the controller enables to assign a sensor or a room unit to each zone and set the influence of the room temperature on the temperature control in the zone. This option is not available on the display.

Pt1000 room sensor

This sensor connects to input AI3 in zone 1. Sensors in zones 2 to 6 can be connected via the module.

RC25 room unit

The RC25 room unit is used to read the room temperature and relative humidity in the heated zone, easily adjust the required temperature using a knob and indicate the operating status and alarm. Refer to the RC25 manual for more information on optional functions.

Two-wire cables are used to install the CIB bus. We recommend using a cable with a twisted shielded pair and a core diameter of preferably 0.8 mm, e.g. J-Y (St) Y 1x2x0.8.

Units for zones 1 to 3 connect directly to the IR controller. Units for zones 4 to 6 require the installation of an external CIB master CF-2141 which connects to the IR controller via an Ethernet interface.

WiFi RSW 30 Wireless room sensor

The wireless room sensor is designed to sense room temperature and humidity in a heated zone. The sensor and controller shall be connected to the same network.

Thermostat

The thermostat in zone 1 can be connected to terminals AI4-AI11.
In zone 2 then via additional modules.

B6. Pre-commissioning Inspection

Before commissioning the device, make sure that:

- the heating system has been properly flushed and filled with clean and treated water
- the installation site requirements specified in chapter B.2 of this manual have been respected
- all protective covers are fitted and secured
- the shut-off valves of the hydraulic circuits are open and that the water flow through the unit is not blocked
- the inlet and outlet pipes to the unit are not interchanged
- the system is properly air vented and pressurized (usually to 1-2 bar) and the vent valve was closed after use
- air pressure in the heating system expansion vessel is by circa 0.2 bar lower than heating system pressure
- there is no water leakage
- that the supplied Magnetfilterball is installed on the return pipe to the heat pump
- the electrical installation is carried out in accordance with the applicable regulations and with the label on the unit (check in particular the size of the power cable, circuit breaker and the correct earthing connection)
- the mains voltage is present at the installation site
- the power cable is not damaged and that the terminals on the wiring are properly tightened
- power supply and control cables of the HP circulation pump are properly connected to connectors on the pump
- the accessories are connected properly
- all documentation for the installed device is available

Only after checking the above points can the circuit breaker of the unit be switched on and the device commissioned.

Note: Commissioning may only be carried out by a person trained by the manufacturer and professionally qualified.

C. SETTINGS USING THE MAIN DISPLAY

A control panel designed for user system settings is located on the front cover.



The panel consists of a display and six control buttons:

- **ESC** to return to the previous screen.
- **ENTER** to select and save a value
- **Up and down arrows** to scroll through menus or adjust values.
- **Two auxiliary buttons** with variable function indicated on the display.

C1. Main menu

The home screen of the controller shows the date, time and temperatures. You can return to the home screen at any time by pressing the help button with the house symbol .

You can scroll through the main menu from the home screen using the down arrow key .

Home screen:



C1.1. Settings for HEATING

To access the HEATING menu from the home screen, press the SETTINGS button .

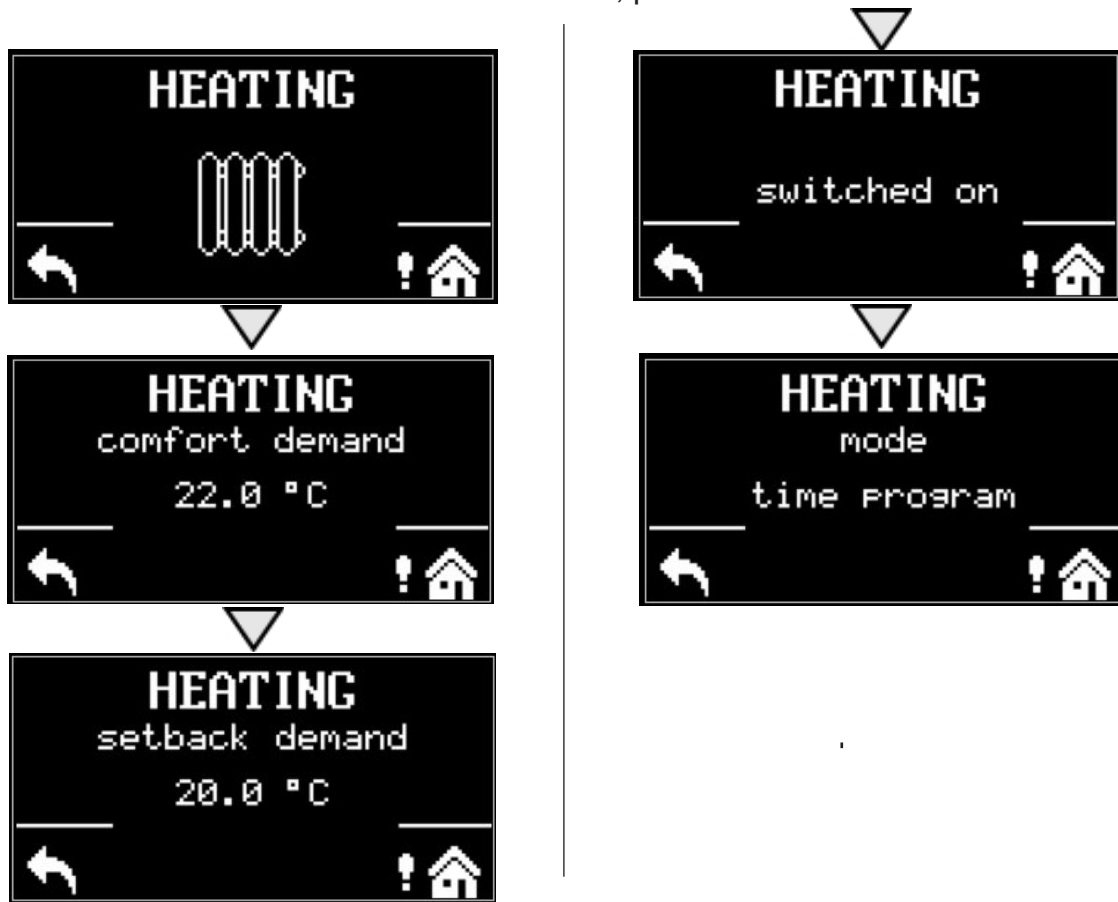

C1.2. Settings for HOT WATER

You can access the HOT WATER menu from the home screen by pressing the SETTINGS button  and then pressing the down arrow button once.

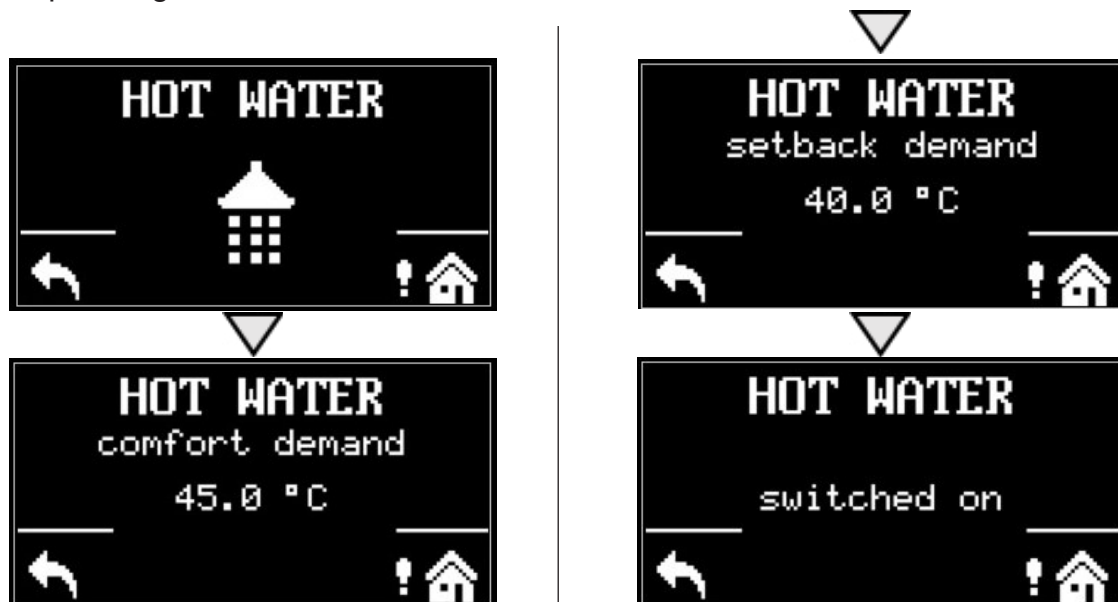

C1.3. Settings for DHW RECIRCULATION

To access the DHW RECIRCULATION menu from the home screen, press the SETUP button  and then press the down arrow button twice.

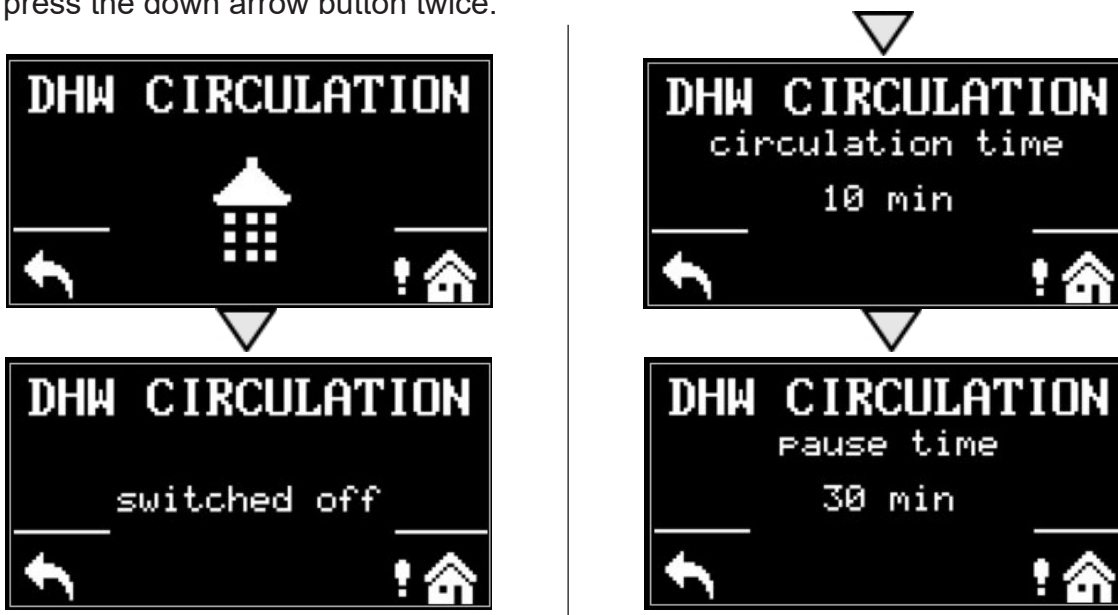

C1.4. Other settings

To access the menus for HEAT PUMP, ADDITIONAL SOURCE and REGULUS ROUTE from the home screen, press the SETUP button  and then press the down arrow button three, four and five times.

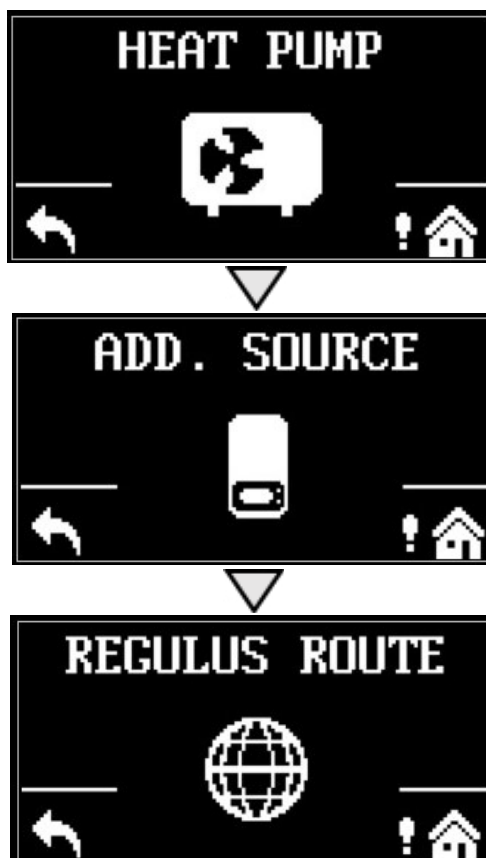

You can switch the heat pump, the auxiliary source or the RegulusRoute function on or off.

D. HOW TO SET ACCESS TO CONTROLLER WEBSITE

The controller contains an integrated website showing an overview of the heating system and user settings. To reach web access to the controller's website it is necessary to connect the controller either to the local network or directly to the PC using a network cable. Alternatively, it is possible to use the IR Client mobile application.

D1. How to connect the controller to a local network

Parameters for network connection (IP address, gateway address and network mask) can be found in the controller information by pressing the MODE button of the service display. To return to the user display, press the MODE button again.

After connecting the controller to the local network, the initial login form will be displayed by entering the IP address into a web browser:

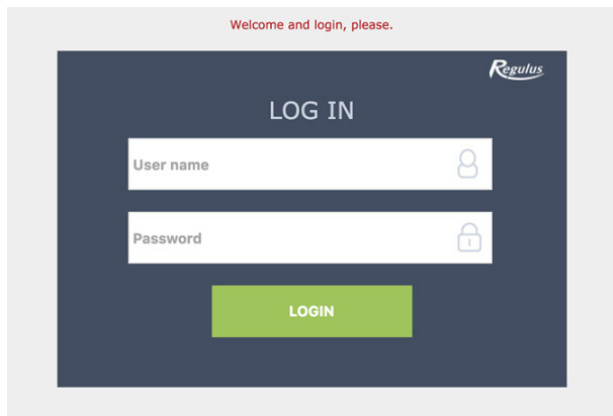

The username for the user level is: **user**,

The password for the user level is: **user**.

D2. How to connect the controller to a PC directly

a) Find out the static IP address of the controller

- Press the MODE button on the controller and then scroll down until the parameters of the ETH2 channel appear on the display. The IP address (second line, IP) is displayed here.

b) Connect the PC and the controller with a network cable

c) Set up a network connection on the PC

- On your computer, right-click the icon showing your Internet connection (small screen icon in the lower right corner).
- Click the Network and Internet Settings link.
- Then click on the Network and Sharing Center - a window with a list of network connections will open.

1. Click on **Ethernet** - a window with the connection status will open
2. Click on **Properties** at the bottom, the Ethernet properties window will open

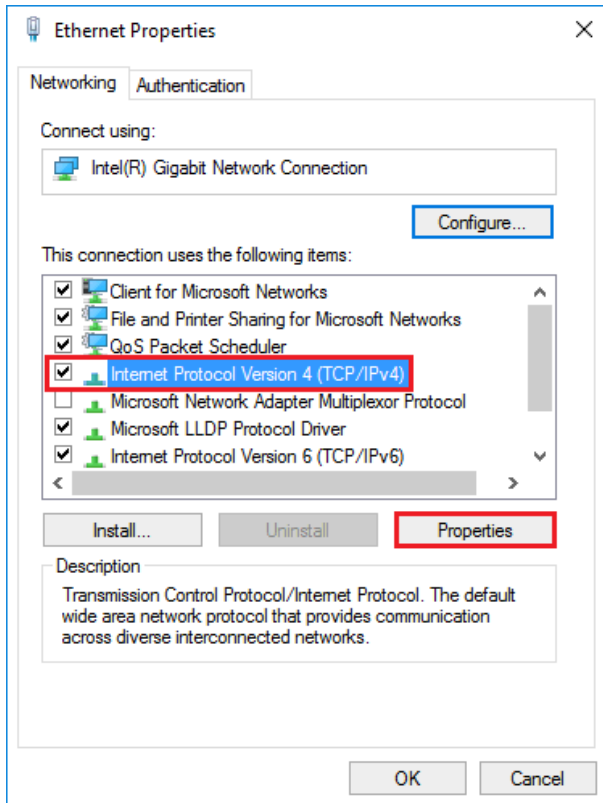

3. Double-click on **IP Protocol version 4** - a window with protocol properties will open. This window can also be accessed in other ways.

4. Select the **Use the following IP address** option and enter the IP address manually in the appropriate box *

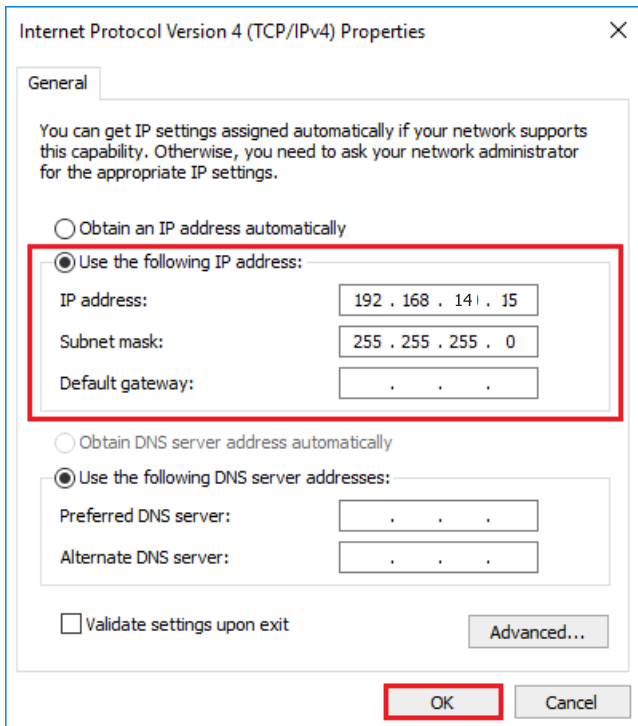

* If you already use the „Use the following IP address“ option, note down the values needed to return to the original setting before changing the settings. **The IP address must match the IP address found from the controller in the first three triple digits and must differ in the fourth triple digits.** In this case, the controller has the address 192.168.14.14 and the PC the address 192.168.14.15. The triple digit must be in the range 001-254. After filling in the IP address, press the tab key on the computer keyboard. This automatically fills in the subnet mask (255.255.255.0). It is not necessary to fill in other fields.

5. Press OK. The window closes. However, to save the settings, it is necessary to press OK also in the previous window with Ethernet settings.

6. Entering the IP address of the controller into the web browser will take you to a login form from which you can visit the user or service level of the controller. Once the computer is disconnected from the controller, we recommend returning the network connection to its original state.

The username for the user level is: **user**,

The password for the user level is: **user**.

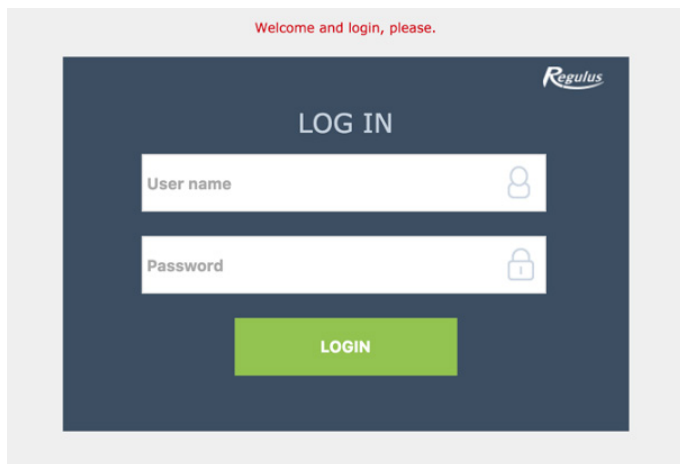

D3. How to connect via Regulus IR Client mobile application

Regulus IR Client is free to download from **Google Play** (for Android) and **App Store** (for iOS).

After logging in to the IR controller via the web interface using the Regulus IR Client application or the RegulusRoute service, the basic screen with tiles is displayed.



Regulus IR Client

Regulus spol. s.r.o. Communication

Everyone

This app is available for your device

Add to Wishlist

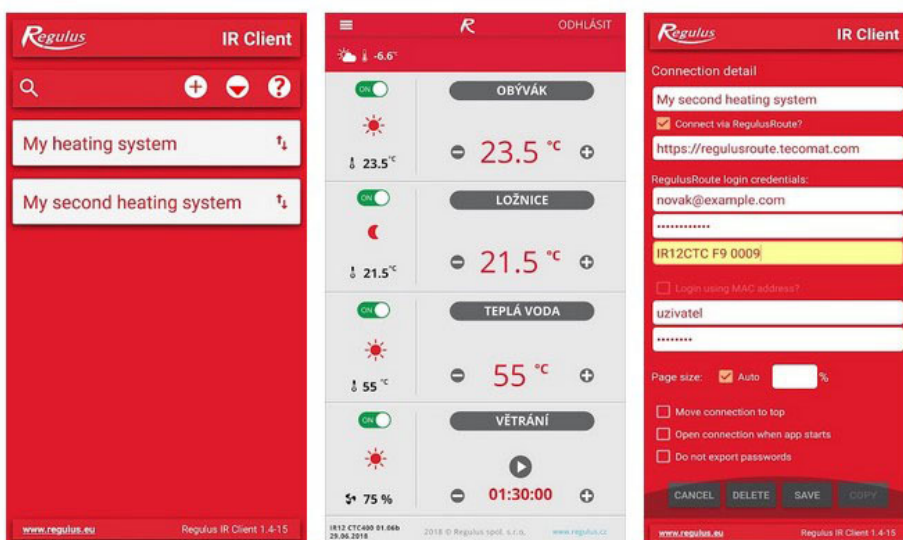

E. SETTING THE CONTROLLER THROUGH WEB BROWSER

E1. SETTING THE CONTROLLER THROUGH WEB BROWSER (HOME)

The home screen contains basic information about the two heating zones, hot water heating, recirculation and ventilation zone.

Service-enabled zones are highlighted in color and can be controlled.

Service-deactivated zones are only shown and cannot be controlled.

Home page shown in your computer browser

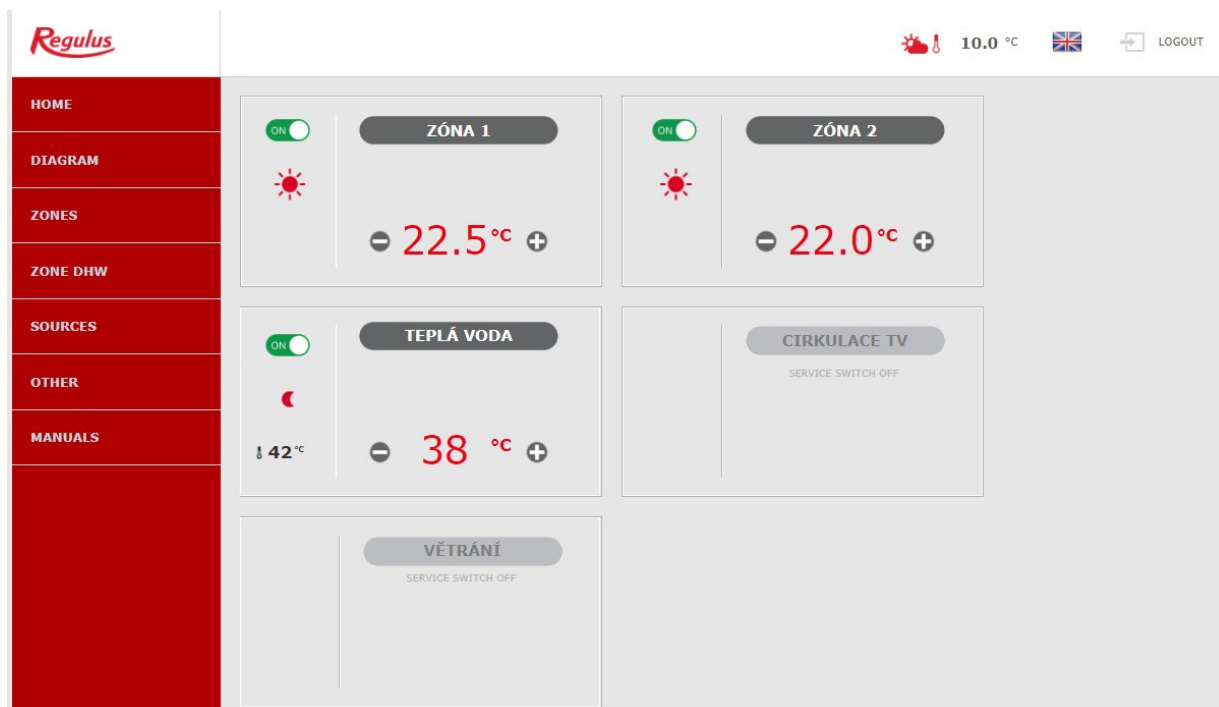

In the left part of the screen there is a menu to enter the individual sections for settings, at the top right there is a button for logging out of the web interface and a flag, allowing to change the language version of the web interface. When editing values (numbers, texts), it is necessary to confirm the change after each change by pressing the **SAVE CHANGES** button.

Home page shown in the Regulus IR Client mobile application



The drop-down menu to enter the individual sections for settings can be opened by clicking on the icon in the upper left corner; the logout button and the flag for changing the language version are located in the upper right corner. When editing values (numbers, texts), it is necessary to confirm the change after each change by pressing the **SAVE CHANGES** button.

E2. Tiles for Heating and Hot Water

When adjusting the temperature using the plus and minus buttons, the desired temperature is adjusted depending on the current mode (T comfort, T setback).

The ON / OFF button is used to turn the zone on or off for user.

You will get to detailed zone setting by clicking on this button.

Sun-moon (comfort-setback). Information on the current zone mode.

Heating zones: current room temperature (if a room sensor is installed)
DHW zone: temperature of DHW

The desired temperature. It can be increased/decreased by pressing the plus/minus button.

E3. Tiles for Hot Water Recirculation and Ventilation

The ON / OFF button is used to turn the zone on or off for by user.

You will get to detailed zone setting by clicking on this button.

Sun-moon (comfort-setback). Information on the current zone mode.

Recirculation: starting the immediate recirculation
HRV zone: starting the boost function

Current output of the HRV unit fan in %.

Recirculation: period for which the immediate recirculation function will be active.
HRV zone: period for which the boost function will be active.
 The time can be increased/decreased by pressing the plus/minus button.

E4. Display of the Diagram (DIAGRAM)

Schematic representation of your hydraulic connection with a clear display of important quantities, states and information. The diagram should therefore always correspond to your current hydraulic connection. For proper display in the mobile application, it is necessary to rotate the device for landscape view.

Display in the upper left corner

OUTDOOR TEMPERATURE - display of the current outdoor temperature

HC pressure - display of pressure in the heating system

RIPPLE CONTROL STATUS - when the controller is wired to the two-tariff electricity supply system, the current status will be displayed here according to the distributor rate (**HIGH / LOW**)

HOLIDAYS - here it is displayed whether or not the holiday function is active; this function makes it possible to adjust the heating temperature of the individual zones and DHW to a lower value during a longer stay outside the heated building, without changing the permanent setting in the individual zones. Holidays are controlled in the HEATING menu.

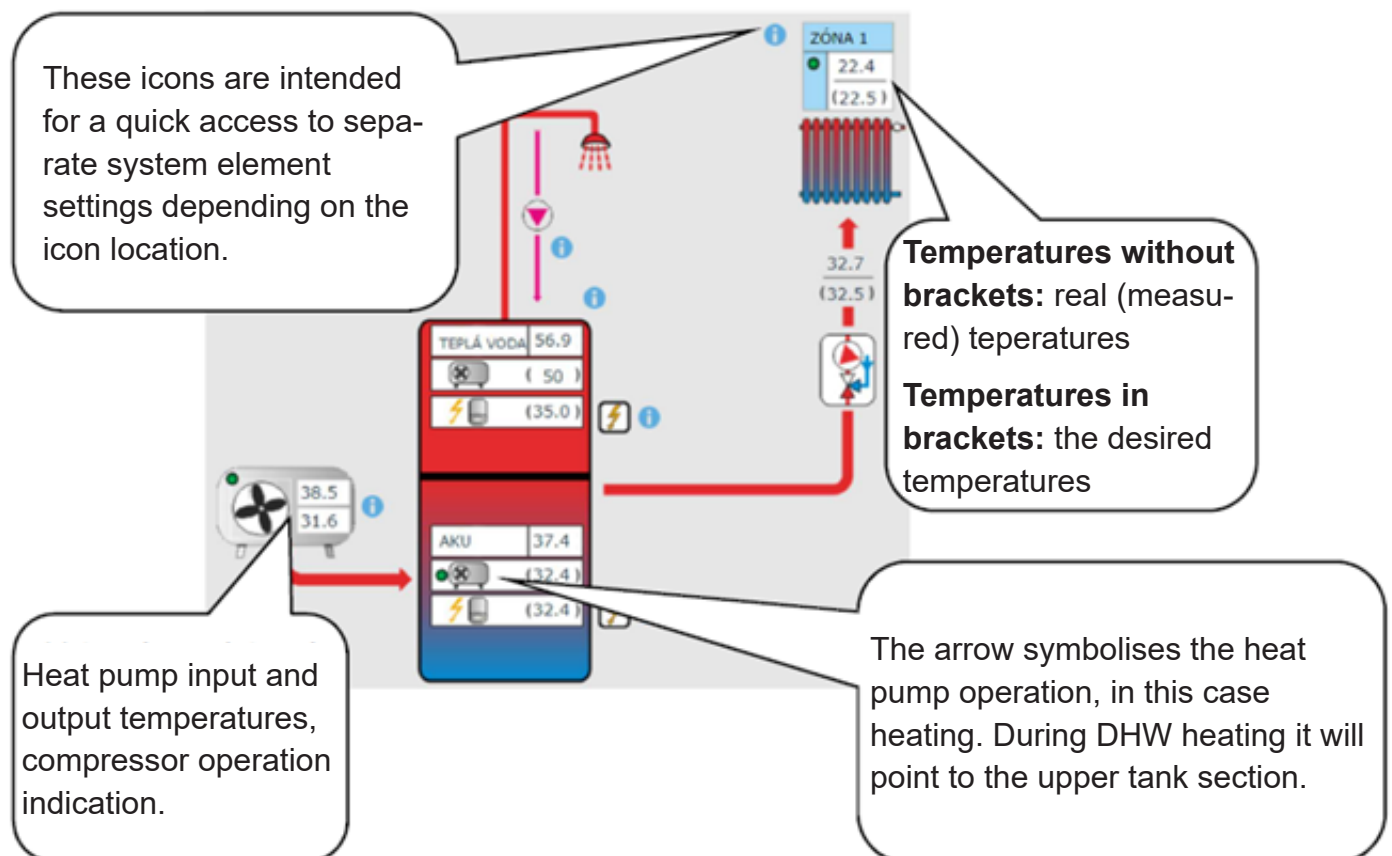

E5. Heating Zone Menu (HEATING)

The menu is used to select the settings of one of the heating zones (Zones 1 to 6), to set the hot water storage tank heating (AKU Zone) and to set the holiday mode (Holidays), or to set the pool heating (Pool heating - if it is controlled by the controller).

E6. Heating Zone Settings (Zone 1 to 6)

The heating zone can be switched on or off by the user with the ON/OFF button. If the zone is switched off by the user, the circulation pump is switched off and the mixing valve is moved to the closed position. *The pump and valve can be switched on by the frost protection (if switched on and active).*

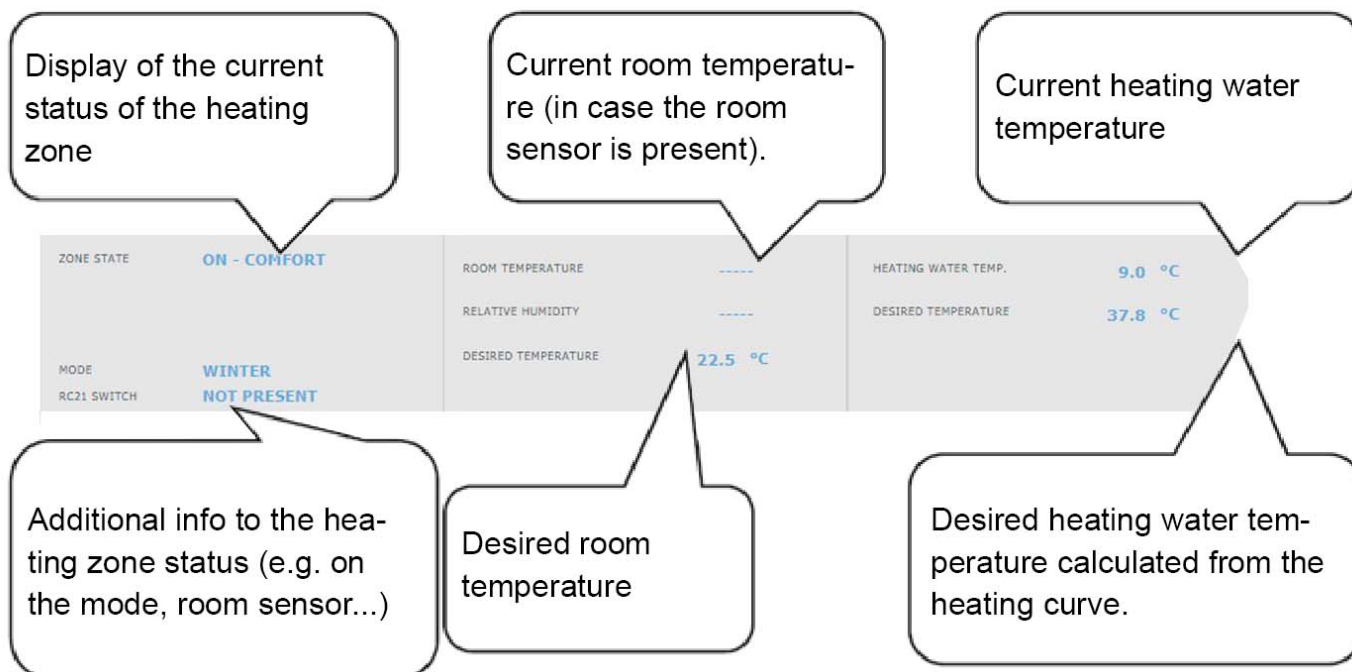

E6.1. Room Temperature Settings

Comfort temperature - setting the comfort temperature in the zone; the temperature can also be changed with the plus and minus buttons.

Setback temperature - setting of setback temperature in the zone; the temperature can also be changed with the plus and minus buttons.

The setback temperature can only be set with the time program switched on.

From the point of view of optimum heat pump operation, the maximum difference between comfort and setback temperature of 1.5 °C is recommended.

When the outdoor temperature drops below -2 °C, comfort mode is automatically activated. This function is designed to save energy so that in the event of a sudden request for a higher zone temperature, an auxiliary (bivalent) heat source does not switch on. This function can be switched off on the service level.

E6.2. Time Program Settings

Zone off during setback - allows you to switch off the heating zone completely in setback mode; the circulation pump stops and the mixing valve closes.

Use time program - switch on the time program to switch the heating zone modes between comfort and setback; if this option is switched off, the heating zone is controlled only by the set comfort temperature. *For systems with underfloor heating, we recommend switching off the time program.*

Use second period - use the second period of the time program; allows a second transition between the setback and comfort modes and back; the times of the individual time periods are preset at the factory, their values can be easily changed by overwriting.

To simplify the settings for individual days, the fields **COPY Mon TO Mon-Fri**, **Mon-Sun** and **COPY Sat TO Sat-Sun** are used. After pressing the respective button, the stored values are copied to the other days according to the description of the button.

E6.3. Setting the Winter/Summer function (blocking heating in the summer)

When activating **HEATING BLOCKED IN SET PERIOD**, enter the date of beginning and end of the period when heating will be always blocked, disregarded of the current outdoor temperature.

When activating **HEATING BLOCKED BY OUTDOOR TEMPER.**, enter the time intervals for the set outdoor temperatures after which heating will be blocked (**SUMMER** mode permitted) and permitted (**WINTER** mode permitted).

Another condition for automatic mode switching is reaching the required indoor temperature. That means if the indoor temperature is lower than desired, no automatic switching to summer mode will occur. Similarly, no automatic switching to winter mode will occur if the indoor temperature is higher than desired.

In the winter mode, zone heating is switched on (the zone is heated to the desired temperature according to the current comfort/setback mode). In the summer mode, zone heating is switched off.

E6.4. Weather Compensating Heating Curve Settings

The basic principle of weather compensation control is to increase the heating water temperature when the outdoor temperature decreases and to decrease the heating water temperature when the outdoor temperature rises in order to maintain a constant room temperature and to prevent overheating or underheating of living rooms.

For efficient system operation, it is important to keep the heating water temperature on a lower level. From the point of view of energy savings and thermal comfort in living rooms, it is more advantageous to heat the building to the required room temperature with a lower heating water temperature for a longer time than with a higher heating water temperature for a short time.

The basic parameters of the heating curve, maximum and minimum temperatures into the zone are set by the service technician during commissioning at the service level.

It can be clearly seen in the graph below that weather compensation control does not represent a direct proportionality in the relationship between the outdoor temperature and the heating water temperature, so it is not represented by a straight line.

This model example shows a system with convection radiators with a temperature gradient of 55/50 °C. The outdoor design temperature is -15 °C, the indoor design temperature is 20 °C and the required indoor temperature is 22 °C. Each building is different and the correct setting is determined by heat loss, climate conditions or altitude. However, the final settings can only be made during normal use of the object.

In the basic mode of displaying the heating curve settings, only the current outdoor temperature and the current desired heating water temperature are displayed. The desired temperature can be changed with the plus and minus buttons.

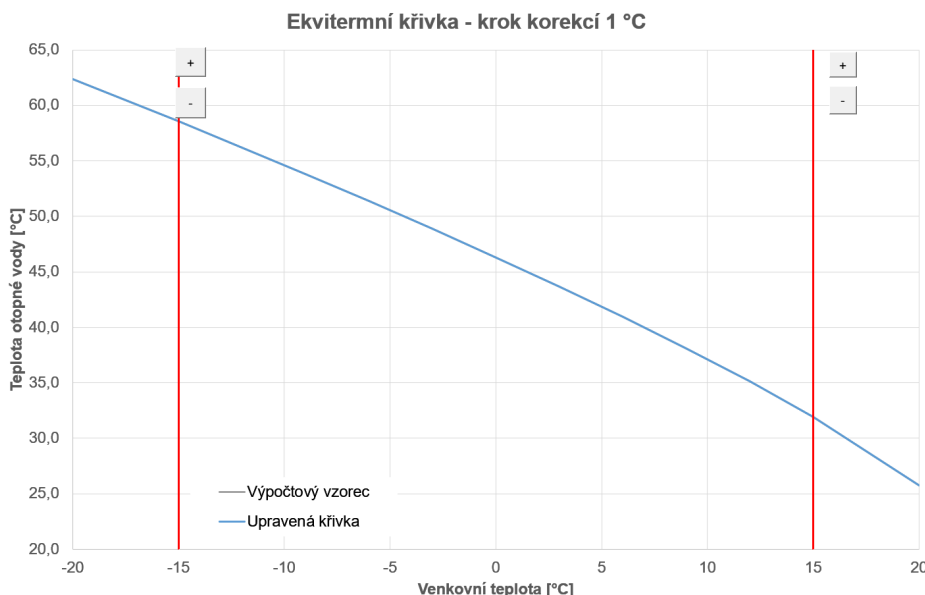

Object overheating at temperatures above zero

Ekvitermní křivka - krok korekcí 1 °C

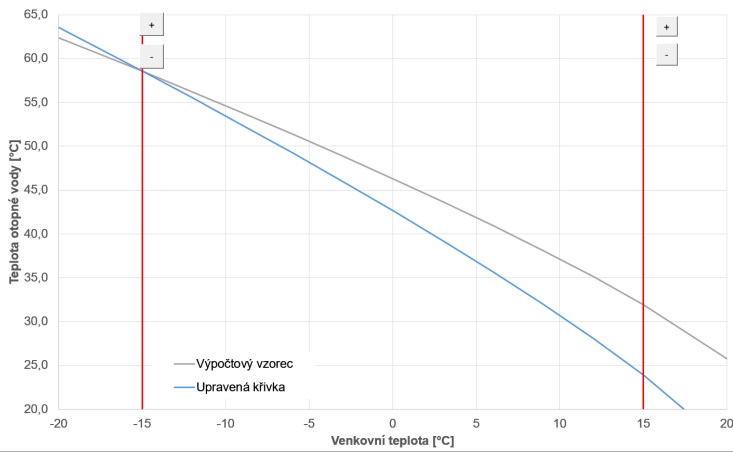

If the building overheats at an outdoor temperature above zero, the heating water temperature must be reduced with the minus button. It can be seen from the graph that the heating water temperature is adjusted mainly at temperatures above the freezing point.

Object underheating at temperatures above zero

Ekvitermní křivka - krok korekcí 1 °C

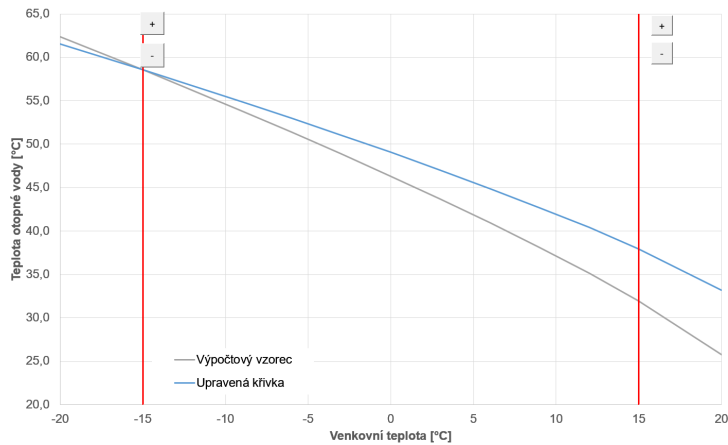

If the building underheats at an outdoor temperature above zero, the heating water temperature must be increased with the plus button. It can be seen from the graph that the heating water temperature is adjusted mainly at temperatures above the freezing point.

Object overheating at sub-zero temperatures

Ekvitermní křivka - krok korekcí 1 °C

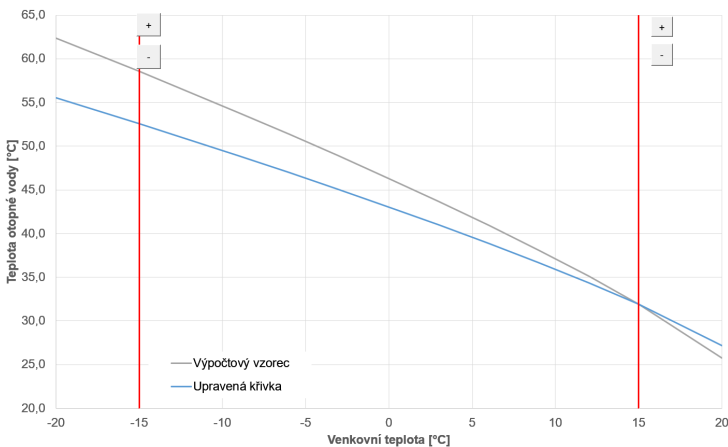

If the building overheats at an outdoor temperature below zero, the heating water temperature must be reduced with the minus button. It can be seen from the graph that the heating water temperature is adjusted mainly at temperatures below freezing point.

Object underheating at sub-zero temperatures

Ekvitermní křivka - krok korekcí 1 °C

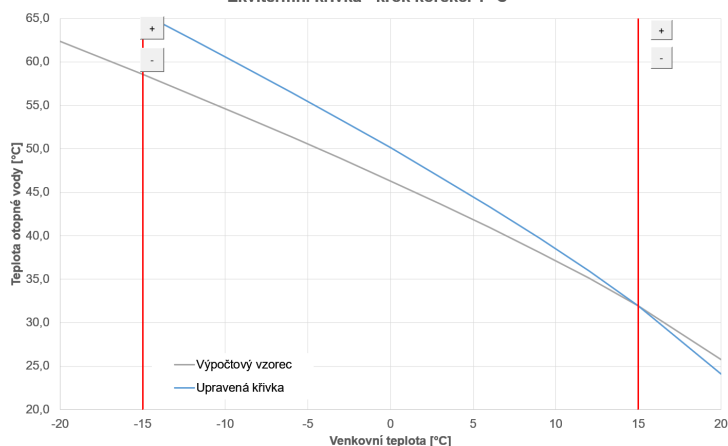

If the building underheats at an outdoor temperature below zero, the heating water temperature must be increased with the plus button. It can be seen from the graph that the heating water temperature is adjusted mainly at temperatures below freezing point.

Expert settings are intended for more experienced users, there are two pairs of plus and minus buttons. One for temperatures above zero and the other for temperatures below the freezing point. By clicking on the individual buttons, the heating curve is reset mainly in the values corresponding to the location of the buttons according to the graphs above.

NEW TEMPERATURE - displays the temperatures adjusted with the buttons at the current outdoor temperature

SAVE CHANGES - confirms the changes made and saves them to the controller's memory

CANCEL CHANGES - returns values, cancelling current adjustments

RESTORE FACTORY SETTINGS - restores the factory settings of the heating curve

The expert settings are fully linked to the basic settings of the heating curve and all changes are reflected in the zone setting.

E7. AKU Zone

The zone of thermal store heating to the set temperature according to the time program. The zone can be switched on or off by the user with the **ON/OFF** button.

This function is mainly used when there is an increased heat demand outside the heating season or to store more heat than is needed for heating. An example would be a swimming pool in combination with underfloor heating.

In the menu of this zone it is possible to set the comfort and setback temperatures for the required thermal store temperature. The actual required thermal store temperature is then calculated as the maximum of the requirements from the AKU zone and the active heating zones.

The time program settings are identical to the time program settings in zones 1 - 6.

E8. Pool Heating

The pool heating function is only available if it is enabled at the service level! Pool heating to adjustable desired temperature. The heating can be switched on or off by the user with the **ON/OFF** button.

E9. Holidays

The holiday function is intended for background heating the building during a longer absence. The holiday function can be switched on or off with the **ON/OFF** button.

After turning on the holidays function, it is important to set the time and date of the start and end of the holidays function. For each heating zone and DHW heating, you can set the temperature to which this zone will be heated during the holidays.

If the heated space is divided into several zones, you can use the **ON/OFF** buttons to determine whether the holiday function will be activated for the whole system or only for the individual zones. If DHW recirculation or HRV zone is connected, you can use the **ON/OFF** button to select whether the specific function will be active during the holidays.

E10. DHW Menu (HOT WATER)

DHW heating is divided into DHW-HP (DHW heating by heat pump), DHW-E (DHW heating by auxiliary source). If the hot water recirculation function is switched on, there is also a SET CIRCULATION tile.

E10.1. Hot Water Heating by Heat Pump

Hot water heating by heat pump can be switched on or off using the ON/OFF button.

At the top of the page, the status of the zone COMFORT/SETBACK and the actual and desired temperature in the hot water storage tank are displayed.

Setting the required temperatures:

Comfort temperature - Setting the comfort hot water temperature.

Setback temperature - Setting the setback hot water temperature.

The setback temperature can only be set with the time program switched on.

The time program settings are identical to the time program settings in zones 1 - 6.

E10.2. Hot Water Heating by Auxiliary Source

The DHW heating by auxiliary source can be switched on or off using the **ON/OFF** button. At the top of the page, the status of the zone **COMFORT/SETBACK**, the actual and desired temperatures in the HW storage tank, the on and off temperature differences and the operating hours of the source are displayed.

Temperature difference for switching the source on/off

SWITCHING ON - switch-on difference; if the real DHW temperature falls by the value of the switching difference below the desired temperature, the source is switched on

SWITCHING OFF - switch-off difference; if the real DHW temperature rises by the value of the switch-off difference above the desired temperature, the source is switched off

Setting the desired temperatures

Comfort temperature - setting the comfort temperature of hot water

Setback temperature - setting the setback temperature of hot water

The setback temperature can only be set with the time program switched on.

The required temperatures from the auxiliary source should be set lower than the desired temperatures from the heat pump in order to avoid unnecessary switching of the DHW-E source.

The time program settings are identical to the time program settings in zones 1 - 6.

E11. Hot Water Recirculation Settings

The DHW recirculation by auxiliary source can be switched on or off by the user with the **ON/OFF** button.

Setting intervals

Recirculation time - setting the running time of the circulation pump (pump running)

Delay time - setting the delay time of the circulation pump (pump stopped)

The time program settings are identical to the time program settings in zones 1 - 6.

Use DHW zone time program - to start the circulation pump, a time program is set identical to the time program of DHW heating by the heat pump

The circulation pump starts according to the set intervals (circulation time and delay time) only in comfort mode according to the time program.

Immediate circulation

After activating this function, the circulation pump is switched on immediately and runs for the set time. After this time, the function switches back to automatic mode according to the time program.

E12. Sources Menu (SOURCES)

In the source menu it is possible to display parameters and adjust some settings of all system sources (heat pump, switched and modulated sources, solar thermal system, solid fuel boiler).

E12.1. Heat Pump

The heat pump can be switched on or off by the user with the **ON/OFF** button.

The screenshot shows a control interface for a heat pump with three main sections: 'COMPRESSOR', 'OVERALL STATISTICS', and 'DOMESTIC HOT WATER STATISTICS'. Callouts provide detailed explanations for various data points shown on the screen.

COMPRESSOR	STOPPED (0 rps)	OVERALL STATISTICS	DOMESTIC HOT WATER STATISTICS
HP STATUS	je v poruše	TOTAL	TOTAL
		STARTS COUNTER	STARTS COUNTER
OUTLET TEMPERATURE	35.0 °C	TODAY	TODAY
INLET TEMPERATURE	34.0 °C	STARTS COUNTER	STARTS COUNTER
HP RUNNING ALREADY	00:00:00	YESTERDAY	YESTERDAY
HP IDLE MORE THAN	596:31:23	STARTS COUNTER	STARTS COUNTER

Callout 1: Current heat pump status, information on compressor operation (for inverter models also the compressor speed)

Callout 2: Heat pump operation statistics - operating hours and number of starts

Callout 3: Statistics of hot water heating by heat pump - operating hours and number of starts

Callout 4: Heat pump inlet temperature (heating return) and heat pump flow temperature

Callout 5: Time period of the current heat pump cycle. How long the pump has been running or stopped in the current cycle.

E12.2. Solar Heating

The solar circuit can be switched on or off by the user with the **ON/OFF** button (the safety recooling functions remain in operation when switched off).

During commissioning, the service technician sets the right differential values for switching the solar system on and off. It sets solar appliances and their values to the current system requirements to ensure long service life and efficiency of solar heating.

The screenshot shows a control interface for a solar heating system. At the top, there are two callouts: 'Current temperature of solar collectors' pointing to a value of 73.3 °C, and 'Information on the operation of the solar pump' pointing to a power level of 10%. Below these, there are three consumer status indicators: 'SOLAR CONSUMER 1' is ON, while 'SOLAR CONSUMER 2' and 'SOLAR CONSUMER 3' are 'Service-disabled'. A detailed view for 'SOLAR CONSUMER 1' shows: Heating: YES; Temperature: 60.6 °C; Demand: 70 °C (with a sun icon); Maximum temperature: 75 °C. A large callout box explains these terms: 'Current temperature: temperature measured by the HW storage tank sensor.', 'Setpoint temperature: desired temperature for solar heating of a given HW storage tank.', and 'Maximum temperature: limit temperature for heating from the solar thermal system.'

E12.3. Fireplace, Solid Fuel Boiler

The fireplace cannot be switched off or on. It is only possible to adjust the outlet temperature of the fireplace, at which the fireplace pump switches on, if the difference is met and the maximum temperature is not reached in the battery. The function of the solid fuel boiler requires an additional module and must be serviced.

Temperature difference for pump control

SWITCHING ON - switch-on difference; if the real temperature measured by the boiler sensor rises by the value of the switching difference above the temperature in the HW storage tank, the pump is switched on

SWITCHING OFF - switch-off difference; if the difference between the boiler temperature and the temperature in the HW storage tank is lower than the switch-off difference, the boiler pump is switched off

The screenshot shows a control interface for a fireplace and boiler system. Callouts explain: 'Current measured values at the control sensors for switching the boiler pump.' pointing to 'FIREPLACE OUTLET WATER TEMPERATURE' (24.2 °C) and 'THERMAL STORAGE - LOWER' (32.8 °C); 'Boiler pump status and air supply damper status - displayed as a percentage of air supply opening or closing (100% fully open, 0% closed).' pointing to 'FIREPLACE PUMP' (status icon) and 'INLET AIR DAMPER' (0 %). Below, a table shows switching differences: ON (5 °C), OFF (3 °C), and limits: TH. STORE MAX TEMPERATURE (95 °C), FIREPLACE MINIMUM TEMPERATURE (50 °C). A callout explains: 'Difference for boiler pump control' pointing to the ON/OFF differences; and 'Limitation of the minimum temperature at the boiler sensor for switching on the pump and the maximum temperature of the HW storage tank for switching it off.' pointing to the 50 °C and 95 °C limits.

DIFFERENCES FOR SWITCHING THE PUMP ON/OFF		LIMITS FOR SWITCHING THE PUMP ON/OFF	
ON	5 °C	TH. STORE MAX TEMPERATURE	95 °C
OFF	3 °C	FIREPLACE MINIMUM TEMPERATURE	50 °C

E12.4. RegulusHBOX Electric Heating Elements

In the RegulusHBOX source, two three-phase heating elements are connected in series with the heat pump, which are controlled automatically according to the desired temperatures for space or hot water heating. The heating elements can be switched off or if needed, also the individual phases of either heating element can be switched off.

The ON/OFF button can be used to switch both heating elements on or off. At the top of the page you will find information about the temperature on the control sensor and the desired temperature for space and hot water heating. On the right side of the page the information about the currently switched outputs of the controller (currently switched phases of both heating elements) is shown.

For each of the two heating elements, it is possible to switch off or on the control of the respective phase (L1, L2 or L3). This reduces the output of the heating element - the heating cartridge has a power of 2 kW per one phase, i.e. the entire heating element has 6 kW and both together 12 kW. This setting can be used to reduce maximum power output or power consumption.

Automatic control of the output of the heating elements (adjustable at the service level) regulates the instantaneous output of the heating elements so that the desired temperature is reached with minimum use of electricity (heating by the heat pump is always preferred). At the bottom of the page there is information on the operation of all six heating cartridges (three for each heating element).

E13. Menu for Other Settings (OTHER)

E13.1. Inputs and Outputs

After clicking on the Inputs/Outputs tile, tables with current information about all sensors, sources, pumps, add-on modules and three-way valves are displayed. This is a complete overview of all connected and unconnected inputs and outputs from the controller.

E13.2. Access and Password

In the Access and Password menu, the login data to the IR controller can be changed. There is also the option of setting MAC addresses for access from the local network without the need to enter a password.

E13.3. General Settings

Here is the information on the synchronization of time and date that is needed for the proper functioning of the time programs for individual zones. There is also the option to turn off the transition to daylight saving time. The system language of the controller is also set here, it can be changed by clicking on the flag.

E13.4. E-mail Notifications

The ON/OFF button can be used to switch e-mail notifications on or off.

The e-mail notification function is used to send e-mails with information about a fault or abnormal operation of the heating system, caused mainly by incorrect user settings. *E-mail notifications only work on a controller that is connected to the Internet.*

For better identification of the controller, it is advisable to fill in the address and contact information for the owner of the device. Information about faults or abnormal operation is sent automatically to the Regulus service department. If you want to send the information to other addresses as well, you can fill it in the **E-mail Recipient** line. Separate the addresses with a semicolon.

The bottom part of the page is used to set the parameters of the connection to the outgoing mail server and in most cases it is not necessary to change them. A change may be necessary only if there is another SMTP server in the network that blocks the use of the default settings. In this case, the function reports an error and it is necessary to contact the Regulus service department.

E13.5. Function Overview

All functions of the controller are displayed in the Function Overview.

Depending on the selected controller setting, the service- and user-switched functions are highlighted here.

E13.6. Fault history

Display of the heat pump fault history and history of other system faults (sensors, communications, modules ...). If the fault is active, it is highlighted in red. Faults written in gray are inactive and are only recorded here.

All faults are recorded in the error log for download.

To download it, click on the icon in the upper right corner of the page.

E13.7. HRV Zone

The zone can be switched on or off by the user with the **ON/OFF** button.

The screenshot shows a control panel for the HRV Zone. It is divided into two columns. The left column displays 'CONTROL SENSOR TEMP.' at 20.6 °C and 'POWER' at 15 %. The right column displays 'UNIT STATE' as 'OFF - USER' and 'SUMMER BYPASS' as 'INACTIVE'. Two callout boxes are present: one on the left pointing to the temperature and power values, and one on the right pointing to the unit state and summer bypass status.

CONTROL SENSOR TEMP.	20.6 °C	UNIT STATE	OFF - USER
POWER	15 %	SUMMER BYPASS	INACTIVE

Performance Settings for HRV Unit

Comfort - Setting the performance of the HRV unit in comfort mode.

Setback - Setting the power of the HRV unit in setback mode.

The performance in the setback mode can only be set with the time program switched on.

The time program settings are identical to the time program settings in zones 1 - 6.

Filter service settings

Setting the service interval of the filter and the possibility to confirm its replacement. The function calculates the operating hours of the HRV unit and, at the end of the filter service life, alerts the user to the need to replace it.

Temporary boost 1, 2, 3

The temporary boost can be switched on or off with the **ON/OFF** button.

Up to 3 temporary boost periods can be preset and then activated in these sections. When the boost function is switched on, the HRV unit sets the performance to the value set in the **Required performance** field for the **Boost time**. After this time, the function is deactivated and the HRV unit returns to automatic mode.

Summer bypass function

The summer bypass function can be switched on or off with the **ON/OFF** button. In this section, the desired temperature and the relative heating zone are set (a room sensor must be located in this zone). If the room temperature in the heating zone is higher than the set limit and at the same time the conditions for the outdoor temperature (set at the service level) are met, the summer bypass opens.

While the function is running, it is possible to set a constant performance of the HRV unit (the unit then ignores the time program and the alternation of comfort / setback modes).

E13.8. Universal Outputs

Information on universal functions (UNI function and UNI function 2). These functions are fully adjustable from the service interface. On the user level the information can be displayed on temperatures and function outputs and the parameters of Thermostat 1 (thermostat related to temperature 1) and Thermostat 2 (thermostat related to temperature 2) and Timers can be set.

E13.9. RegulusRoute

The RegulusRoute menu displays information about remote controller management. You will use this information when communicating with a service technician if the controller is unavailable through the RegulusRoute service for any reason.

E14. Manual Access Menu (MANUALS)

In the Manuals menu you will find this manual and the manuals for the RCM and RCD room units.

F. ADJUSTING THE CONTROLLER THROUGH THE SERVICE DISPLAY

Warning: The service display is located in the electrical installation section of the device, where the live components are located. Therefore, the service display can only be operated by a service technician with electrical qualification.

F1. Controller Input

In the menu, scroll through the displays using the ▲ ▼ buttons. Increase/decrease the numerical parameters with the ▼ or ▲ buttons. Select the parameters to be selected (e.g. on/off) with the ◀ ▶ buttons. To edit one of the parameters, press the × button and the cursor will appear on the parameter. To finish editing the parameter, press the ✓ key, the cursor automatically jumps to the next parameter on the current display. Parameter editing can be terminated without saving the newly set value with the × key. Pressing the × key in the user basic menu always returns the menu to the first - basic display.

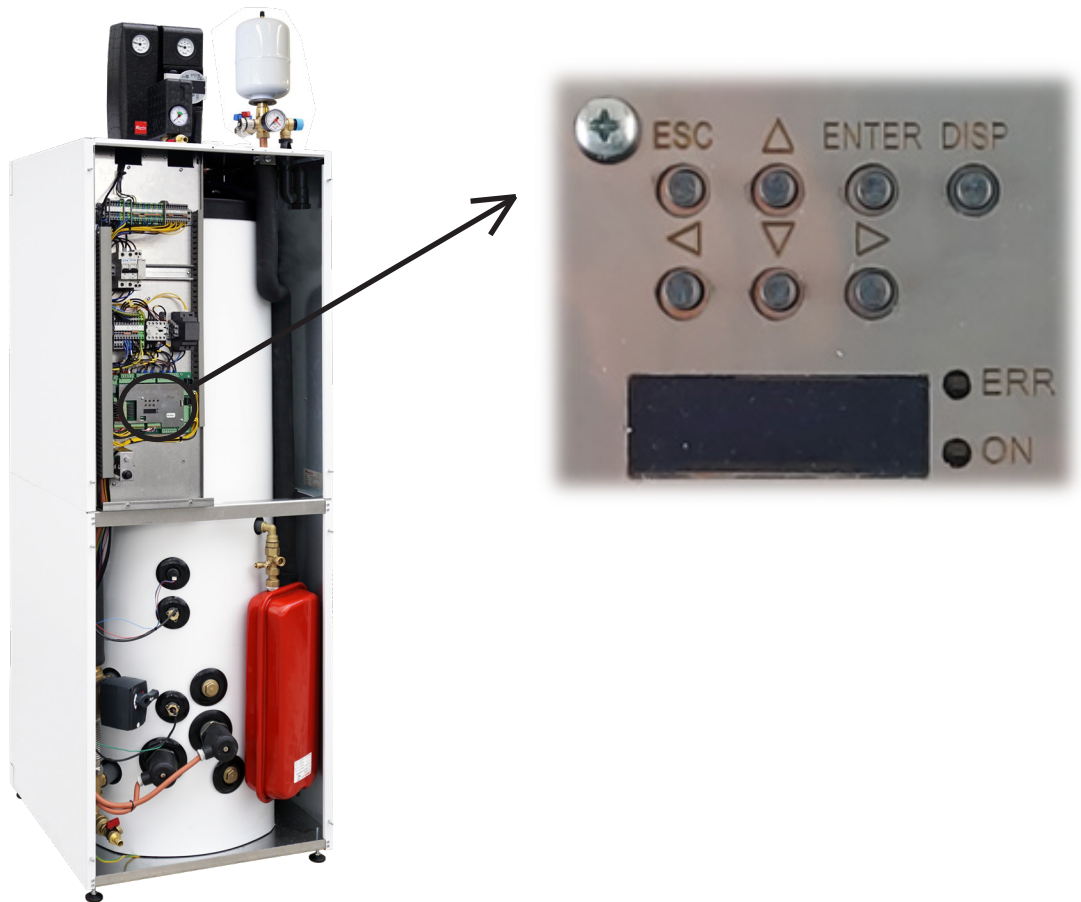

F2. Overview of Parameters Displayed on the Service Display

F2.1. Basic Display

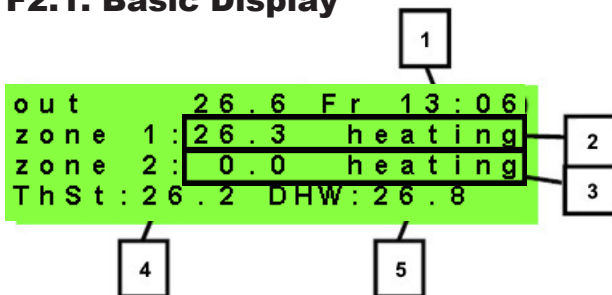

- 1 - day of the week and time
- 2 - zone temperature (if a room temperature sensor is used)
- 3 - heating water temperature (if no room temperature sensor is used)
- 4 - temperature in the thermal store (if present in the system)
- 5 - temperature in the hot water storage tank

F2.2. Zone Display (zone 1, zone 2)

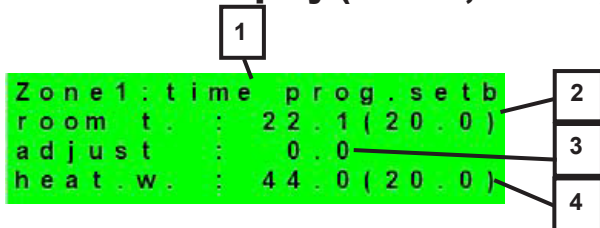

- 1 - zone status (information on the current status of the heating zone)
- 2 - actual and desired room temperature (if a room sensor is not used, the value is 0.0)
- 3 - correction of the desired room temperature; when a room unit is used, the „PJ“ symbol is displayed and the correction by this unit is displayed
- 4 - actual and desired heating water temperature to the zone

The table below lists the possible operating states indicated on the service display and their equivalent in the web interface of the controller:

Indication on the service display	Indication on the web interface
off by service	DISABLED BY SERVICE
off by user	DISABLED BY USER
low syst.press	TOO LOW SYSTEM PRESSURE
extern. block	BLOCKED EXTERNALLY
store low t-HP	THERMAL STORE BELOW HP MIN. TEMP.
fast loading	FAST BOILER/FIREPLACE LOADING
stor.low t-zon	THERMAL STORE BELOW ZONE MIN.TEMP.
max.z.temp.exc	MAX. ZONE TEMPERATURE EXCEEDED
block-cool.t.	COOLING BELOW ZONE TEMPERATURE
cool.other z.	COOLING IN ANOTHER ZONE
block-period	HEATING BLOCKED IN SET PERIOD
block-outd.t.	HEATING BLOCKED BY OUTDOOR TEMPER.
off-time prog.	TIME PROGRAM – SETBACK, ZONE OFF
block-room t.	ROOM TEMPERATURE REACHED
air cooling	AIR COOLING
cool. active	COOLING ACTIVE
floor drying	FLOOR DRYING PROGRAM
comf-low out.t	COMFORT - LOW OUTDOOR TEMPERATURE
time prog.comf	TIME PROGRAM – COMFORT TEMPERATURE
time prog.setb	TIME PROGRAM – SETBACK TEMPERATURE
th.st.overheat	THERMAL STORE OVERHEATED
holidays	HOLIDAYS
perm. comfort	COMFORT TEMPERATURE CONTINUOUS
perm. setback	SETBACK TEMPERATURE CONTINUOUS
DHW heating	DHW BEING HEATED
heat.- holid.	HOLIDAYS
cool. holid.	HOLIDAYS

F2.3. Solar Thermal System Display

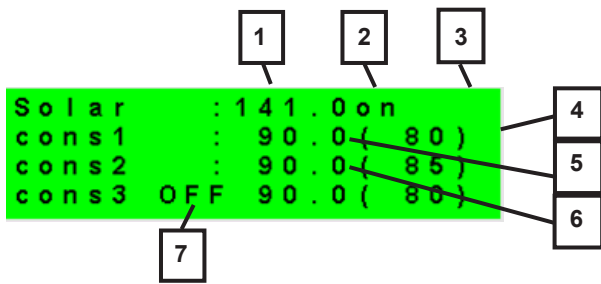

- 1 - solar collector temperature
- 2 - turn on the system
- 3 - ON = solar pump running
- 4 - mark of the currently heated hot water storage tank
- 5 – HW storage tank 1, actual temperature (desired in solar heating)
- 6 – HW storage tank 2, actual temperature (desired in solar heating)
- 7 - HW storage tank 3, not used

F2.4. Display of Hot Water Zone Heated by Auxiliary Source (DHW-E)

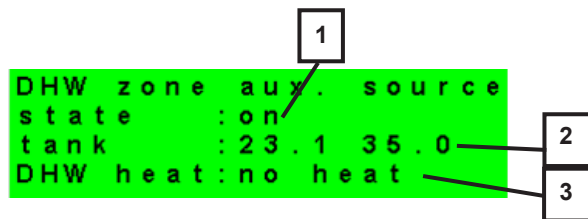

- 1 - zone status (on / off / no)
- 2 - actual and desired temperature in the HW storage tank
- 4 - heating by electric cartridge (heating / no heat.)

F2.5. Display of Hot Water Zone Heated by Heat Pump (DHW)

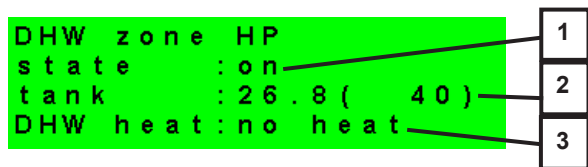

- 1 - zone status (on / off / no)
- 2 - actual and desired temperature in the HW storage tank
- 3 - heating by heat pump (heating / not heat.)

F2.6. Display of Heat Pump, Heat Pump Cascade (HP in series)

```

HP
HP1 :  o n
HP2 :  o f f
HP3 :  o f f
    
```

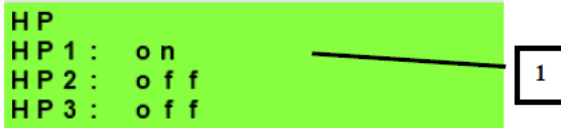

1 - status of heat pump No. 1, No. 2 and No. 3.

This section shows the states of the heat pumps that are enabled on the service level.

The states can be as follows:

OFF - service	: heat pump is turned off by a heating engineer
OFF - user	: heat pump is turned off on the User level
fault	: heat pump is in alarm mode, alarm details are shown on the User level in HP Alarms menu
return - max.T	: heat pump is blocked by max. possible return temperature
flow - max.T	: heat pump is blocked by max. possible flow temperature
ambient – min.T	: heat pump is blocked by min. possible outdoor temperature
ambient – max.T	: heat pump is blocked by max. possible outdoor temperature
sup.refrig.vapor	: heat pump is blocked by max. compressor temperature
high T earth circ.	: heat pump is blocked by max. brine circuit temperature
vapor –low T	: heat pump is blocked by low evaporation temperature
vapor – high T	: heat pump is blocked by high evaporation temperature
cond. – high T	: heat pump is blocked by high condensing temperature
EEV-low T intake	: heat pump is blocked by expansion valve's low suction gas temp.
EEV-low T vapor	: heat pump is blocked by expansion valve's low evaporation temper.
EEV-high T vapor	: heat pump is blocked by expansion valve's high evaporation temper.
EEV-low superheat	: heat pump is blocked by expansion valve's low superheat temper.
EEV-high p cond.	: heat pump is blocked by expansion valve's high condensing temper.
high pressure	: heat pump is blocked by high refrigerant pressure
defrosting	: heat pump is defrosting (only for air/source heat pumps)
min.run time	: HP min. running time is active. This activates always after start, DHW heating or defrosting
DHW heating	: heat pump is heating DHW
rebooting	: heat pump is blocked by min. time between 2 comperssor stars
heating	: heat pump is heating your home
RC blocking	: heat pump is blocked by Ripple control
vol.flow control	: heat pump's circulation pump is running
ready	: heat pump is ready to start heating as soon as there is call for heat
vapor - low T-IR	: heat pump is blocked by low evaporation temperature
vol.flow control-IR	: heat pump's circulation pump is running
IR internal error	: controller error preventing successful start of the heat pump
external blocking	: the start of the heat pump is blocked externally
heating from the PV	: heat pump is using energy from a PV system
waiting for PV	: heat pump is waiting for a PV system to reach the desired values of current to start
low flow	: water flow through the heat pump is too low
PWM pump failure	: failure of the circulation pump controlled by the PWM signal
PWM mod.disconnected	: the PWM output module is disconnected (if used)
compr.driver error	: heat pump compressor driver error
min.run time - DHW	: min. running time of the heat pump when heating DHW
min.run time - PV	: minimum running time when the heat pump is power supplied from a PV system

F2.7. Display with Firmware Version and Release Date

```
IR RegulusHBOX CTC
FW: v1.0.8.0
07.03.2023
www.regulus.cz
```

F2.8. Controller in Factory Settings

If there is the screen shown on the display (see below) with a warning about setting the controller to factory settings, it is necessary that a service technician sets the relevant parameters of the controller.

```
!WARNING!
After failure
controller reset to
FACTORY SETTINGS!!!
```

F2.9. Select the Desired Setting (menu)

```
* * * * *
*           settings           *
*       < for user >         *
* * * * *
```

User settings	user settings of zones, DHW heating and other parameters, structure of settings in more detail in the following chapter: Heating zones ► HRV zone ► Time program ► Weather-compensating curves ► Heat pump control ► Heating element control ► HP faults ► Other faults ► Setting the DHW heating from the heat pump (DHW-HP) ► Setting the DHW heating via an auxiliary source (DHW-E) ► Thermal store heating settings ► DHW recirculation settings ► Statistics ► Operating data ► Others ► Date and time settings ► RegulusRoute - service connection parameters
Add-on modules	display of basic information from add-on modules, if used
Service settings	service settings of zones, hot water heating, sources and other parameters Access to the service menu is password protected and parameter settings in the service menu can only be performed by professionally qualified persons!
Recirculation	setting the immediate DHW recirculation (circulation time); after the set circulation period ends, the function switches off automatically
Z3 to Z6	basic settings for heating zones 3 to 6 (these zones need to be connected to the IR through add-on modules)

F3. User Settings

Use the ◀ ▶ buttons to select between the options in the user settings; confirm the selection with the ✓ button; after completing all settings, press the × button to return to the first - basic display.

F3.1. Heating Zones

Basic settings of the heating zone

T comfort (°C)	setting the comfort temperature in the zone (desired room temperature)
T setback (°C)	setting the setback temperature in the zone (desired room temperature) <i>during the day the controller switches the desired room temperature according to the set time program (for zones 3 to 6 adjustable only from the web interface)</i>
zone on	switching on the heating zone by the user; if the zone is switched off by the user, the circulation pump is switched off and the mixing valve is shifted to the closed position <i>the pump and valve can be switched on by frost protection (if switched on and active)</i>

Winter/Summer function

The winter/summer function is used to switch on the zone heating if the outside temperature is below a set temperature (**winter temperature**) for a certain time (**time for winter**) and vice versa to switch off the zone heating if the outside temperature is higher than the set temperature for switching to summer mode (**summer temperature**) for a certain time (**time for summer**).

Status	switching on/off the function for automatic transition between summer and winter mode
summer temp (°C)	if the outdoor temperature is above this temperature for the time specified in the Time for summer parameter, the zone switches to <i>summer mode</i>
summer time (h)	see parameter <i>summer temperature</i>
winter temp (°C)	if the outdoor temperature is below this temperature for the time specified in the Time for winter parameter, the zone switches to <i>winter mode</i>
winter time (h)	see parameter winter temperature

F3.2. HRV Zone

Basic settings of HRV zone

comfort (%)	setting of the HRV unit performance in the „comfort“ mode in the range 0-100%
setback (%)	setting of the HRV unit performance in the „setback“ mode in the range 0-100%
zone on	switching on the HRV zone by the user

During the day, the controller switches the desired. output of the HRV unit according to the settings of the time program (adjustable from the web interface only)

Boost 1, 2, 3 function settings

boost function 1, 2, 3	turning on the instant boost function; the output of the HRV unit increases temporarily for the time period set by the time parameter to the value set by the performance parameter; after the set time for boost elapses, the HRV unit switches back to automatic mode; this function can also be switched on with a button wired to one of the controller inputs (see service level)
power (%)	see the Boost 1, 2, 3 parameter
time (hh:mm)	see the Boost 1, 2, 3 parameter

Summer bypass settings

summer bypass	turning on the summer bypass function; this function can be related to the room sensor of one of the heating zones (but only if a room sensor or a room unit is present in the given zone); the sensor used is defined by the parameter function related to the zone ; the function opens the bypass damper if the outdoor temperature is lower than the set room temperature at the selected room sensor (desir.temper. parameter); the outdoor temperature must also be higher than the service-set minimum outdoor temperature; the summer bypass function can be started only in the summer mode of the selected zone (service adjustable parameter)
assign function to (zone number 1 – 6)	see the summer bypass parameter
request t. (°C)	see the summer bypass parameter

F3.3. Time Programs

Setting the time program by days - set for each day of the week two transitions from setback mode to comfort mode and two transitions from comfort mode to setback mode.

Setting the time program block by block - set the transitions similarly for the Mon-Fri and Sat-Sun block. Selecting *copy YES* will overwrite the corresponding time program blocks. If you do not wish to copy the time programs, leave the option to *copy NO*, and exit the menu with the **x** button.

Setting the holiday mode - for the set period it is possible to set the temperatures of individual zones to which the controller will regulate the temperature.

F3.4. Weather Compensating Heating Curves

The basic heating curve in the controller is calculated from the parameters of the heating system that were entered on the controller service level. The basic curve can be rotated and shifted using a pair of parameters on the user level.

OTC curve shift (°C) offset of the heating curve for the entered outdoor temperatures of -15 °C and + 15 °C. When moving the curve at one of the points, the other point always remains unchanged (i.e. the curve rotates around it). To shift the entire curve, it is therefore necessary to enter the same value as both shift values.

On other displays it is possible to display the adjusted heating curve described by the four points [E1, I1] to [E4, I4] where E1, E2, E3 and E4 are the entered outdoor temperatures and I1, I2, I3 and I4 are the calculated required weather-compensated heating water temperatures.

F3.5. Heat Pump Control

HP1, HP2, HP3 - User switching on/off one of the heat pumps in the cascade. The heat pump switched off by the user still communicates with the controller, but no requests from the heating system or the hot water system are transmitted to it.

F3.6. HP Faults

In the heat pump faults menu, it is possible to reset the faults of all heat pumps (by changing the Reset all faults option to Yes). Use the down arrow to scroll through the heat pump fault history.

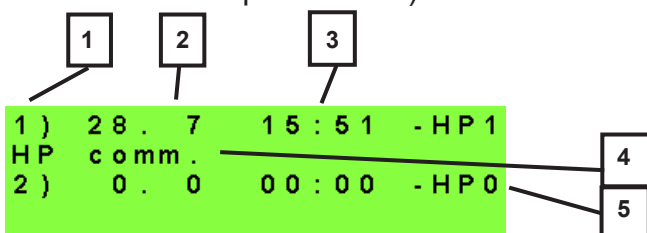

- 1 - serial number of the fault (1 - 10)
- 2 - date and time of failure
- 3 - information if the fault is still active (A)
- 4 - serial number of the HP with a fault (1 - 10)
- 5 - text description of the fault

F3.7. Other Faults

List of recent controller faults except heat pump faults. These faults include, for example, errors of sensors, connected modules, errors of sources.

F3.8. Settings of DHW Heating by the Heat Pump (DHW-HP)

DHW on	user activation of DHW heating by the heat pump
T comfort (°C)	desired temperature in „comfort“ mode
T setback (°C)	desired temperature in „setback“ mode

During the day, the controller switches the desired DHW temperature from the heat pump according to the set time program.

F3.9. Settings of DHW Heating by Auxiliary Source (DHW-E)

Basic settings

DHW on	user activation of DHW heating by an auxiliary source
T comfort (°C)	desired temperature in „comfort“ mode
T setback (°C)	desired temperature in „setback“ mode

During the day, the controller switches the desired DHW temperature from the auxiliary source according to the set time program.

Legionella Function

The Legionella function is used for thermal „disinfection“ of the hot water storage tank, especially against Legionella bacteria. If this function is switched on, the HW storage tank will heat up to a temperature of at least 65°C once a week on the selected day and hour. The heating is switched off when this temperature is reached, or after two hours from switching on the function regardless of the temperature reached.

on (on/off)	user activation of Legionella function
day (weekday: mo-su)	day of the week when the function is switched on
Hour (hour)	hour when the function is switched on

F3.10. Settings of Thermal Store Heating

During the day, the controller switches the desired thermal store temperature according to the set time program. The actual required thermal store temperature is the maximum of all requirements from the zones (heating zones, AKU zone, requirements from universal functions ...).

DHW-E on	user activation of thermal store heating
T comfort (°C)	desired temperature in „comfort“ mode
T setback (°C)	desired temperature in „setback“ mode

F3.11. Settings of DHW Recirculation

User setting of hot water recirculation and its time program. If the recirculation is switched on, it is performed following the time program set for each day. For this time interval, the running time of the circulation pump and the delay of the circulation pump can be set, supposed the circulation pump shall not run continuously.

on (off / on)	activation of recirculation function
circ. time (min)	setting the circulation pump running time (pump running)
idle time (min)	setting the circulation pump delay time (pump stopped)
circulation times	setting of time intervals for individual days when the circulation is performed

F3.12. Statistics

Display of heat pump statistics (operating times and number of compressor starts) and operating statistics for hot water and auxiliary source.

F3.13. Operating Data

It shows the user all temperatures, pressure, the most important temperatures and states of the heat pumps and the values at the controller outputs. If the letter **E** appears at the end of the temperature sensor line, the given temperature sensor is outside its permitted working range and it is necessary to check this sensor and its connection and correct the fault.

```

out          0 . 0
zone 1      0 . 0 off
zone 2      0 . 0 off
heat z1     0 . 0 ( 0 . 0 )
  
```

F3.14. Other

website password reset (no,reset)	reset of username and password to access the controller website on the user level (reset option); reset returns the factory value (name: user, password: user)
language for error messages and HP state:	selection of the language in which the heat pump states, sensor names, blocks and system faults will be shown on the display and on the web

F3.15. Date and Time Settings

For the correct operation of time programs (zones, recirculation, DHW heating...) it is necessary to set the time and date. The clock is set in 24-hour format. If the controller is connected to the Internet, the date and time are automatically updated every hour using NTP time servers.

After setting the time and date and pressing the **▼** key, the display below will be shown. When this display appears, the time and date will be stored in the controller memory.

```

Saving time      OK
press "C" for return
  
```

F3.16. RegulusRoute - Service Connection Parameters

RegulusRoute service allows remote access to the controller without the need to use a public IP address. Please contact Regulus to configure the service.

RegulusRoute (yes/no)	indicates whether the service is switched on
Status	displays the current service status and error information followed by IR driver status information, the status of the remote server of the RegulusRoute service and a detailed description of the last service error; this information can be helpful when solving connection issues with a service technician
IR name	IR login name for RegulusRoute service

F4. Add-on Modules

When selecting Add-on Modules in the main menu, user information for add-on modules can be viewed if they are used in the controller.

F4.1. Fireplace Module

```
Fire          absent
temperature : 0.0 °C
damper       : 00%
DHW pump     : none
```

Temperature (°C) – displays the fireplace flow temperature.

Damper (%) – displays how opened the fireplace air inlet damper is.

DHW pump – displays the status of the pump for DHW heating from Thermal Store (running/off).

F4.2. UNI Module, UNI Module 2

```
UNI module   absent
output       : off
temp. 1      : 0.0
temp. 2      : 0.0
```

Output (on/off) - displays the status of the universal output at the UNI module (1, 2).

T1 (°C) – displays temperature t1 from UNI module (1, 2).

T2 (°C) – displays temperature t2 from UNI module (1, 2).

G. MAINTENANCE

G1. Maintenance by the User

It is recommended to perform this type of maintenance once a month:

- Pressure check (locally or remotely via remote access). If necessary, air vent and top up water to the heating system.
- Visual inspection for possible water leaks from the unit or piping.
- Cleaning the outer casing with non-aggressive and non-abrasive cleaning agents (e.g. a slightly damp piece of cotton cloth).
- Checking the safety valve function (by slightly turning the valve knob).

G2. Removing the Front Covers

The front covers are mounted on four pins located on the side covers. Follow the picture below to remove the front covers.

The front covers are mounted on four pins located on the side covers. Follow the picture below to remove the front covers.

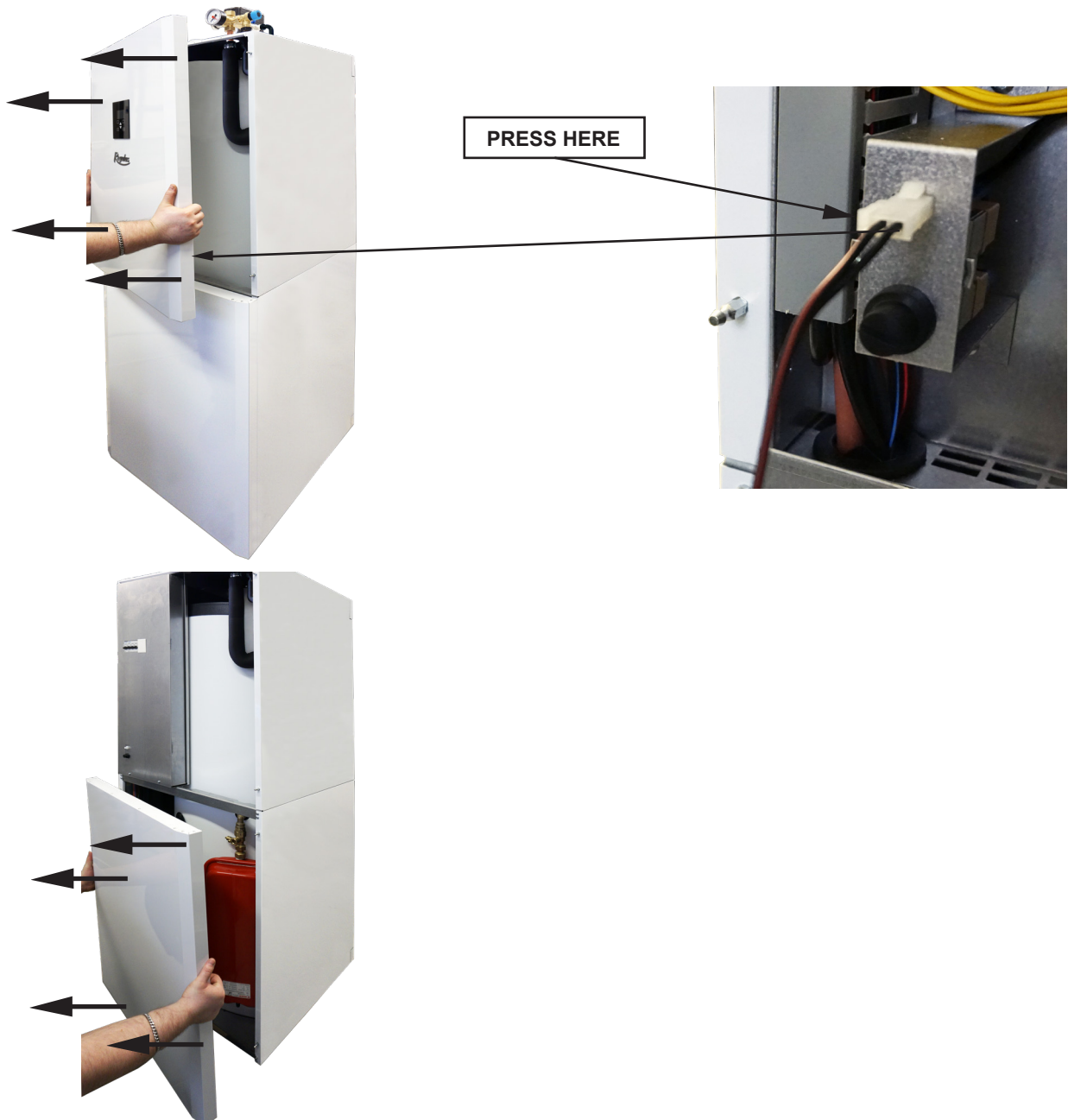

G3. Removing the Wiring Cover

Warning: Danger of electric shock if live parts are touched! Before starting work, disconnect the RegulushBOX from the power supply (by switching off the relevant circuit breaker in the house switchboard).

Disassembly of the wiring cover may only be carried out by a person professionally qualified in accordance with EN 50110-1!

The cover is attached with two screws at the bottom. After unscrewing them, the cover can be released and removed by moving upwards. The detail of the attachment is shown in the picture below

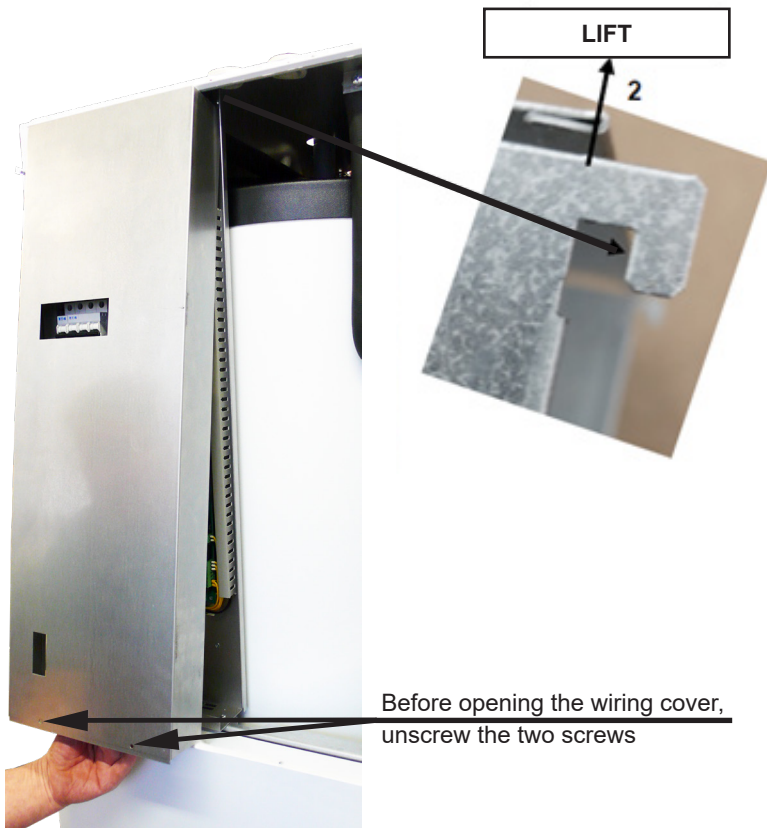

G.4. Professional Maintenance

It is recommended to perform professional maintenance once a year by a service technician with professional qualifications:

- Check the electrical installation (circuit breakers, contactors, cables) and tighten the connections
- Check that all safety elements are working properly
- Adjusting the pressure of expansion vessels
- Cleaning the ball valve with filter&magnet in the return pipe to the heat pump
- Check water pressure and tightness of connections
- Check heating elements, pump and three-way valve

G.5. Discontinuing Operation

If there is a risk of water freezing in the device (e.g. if the device is out of operation in an unheated room), drain all water from the RegulusHBOX, the heat pump and the pipes - especially in places where the temperature may drop below 0 °C. And also turn off the RegulusHBOX circuit breaker in the home fusebox.

G.6. Recycling / Disposal

The device must not be disposed of with municipal waste.





Dispose of steel, copper and copper alloy components in the sorted metal waste collection.

Electronic components, such as electronic boards, must be handed in at a collection point for electrical waste.

H. SERVICING

Faults of the circulation pump of the heat pump circuit

The operating status and possible faults of the pump are displayed by means of LED signals directly on the pump.

LED signals	State description and possible fault reasons	
	green is lit	– pump is running in trouble-free operation
	red is lit	– rotor is blocked – electric motor winding defect
	flashing red	– power supply lower/higher than permitted – electric short circuit in pump – pump overheated
	flashing red and green	– unforced fluid circulation through the pump – pump speed lower than desired – air in pump

in case of some faults the pump will switch off and try to restart

Temperature resistance table for Pt1000 sensors

°C	0	10	20	30	40	50	60	70	80	90	100
Ω	1000	1039	1077	1116	1155	1194	1232	1270	1308	1347	1385

H.1. Fault Indication

If a fault occurs, an exclamation mark appears next to the house icon on the display .



After pressing the button under the exclamation mark, faults will be displayed in this order: on pos. 1-3 heat pump faults, on pos. 4-5 other faults. On position 6 there is a screen for reset of heat pump faults.

H.2. Record of Repairs and Inspections

Date	Operation performed	Service company Name, signature and stamp	Custo- mer's signature

